



LAMY RHEOLOGY

INSTRUMENTS

VISCOSITY | RHEOLOGY | TEXTURE | TRAINING

2023 | 2024

LAMY RHEO

A FRENCH MANUFACTURING !

LAMY RHEOLOGY is a long-time leader in the field of Rheology.

For more than 65 years, LAMY RHEOLOGY has supported you in the design and analysis of your products, by manufacturing your measuring instruments, viscometers, rheometers, texture analyzers and temperature controls.

As the only French manufacturer of viscometers and rheometers, our desire is to defend the «Made In France», which is why all our instruments are carefully manufactured in France in workshops on a human scale. The entire manufacturing process is carried out in France. With us, the assembly of our machines is carried out by our employees who master our know-how and are fully committed to respecting quality.

In this context of improvement, our innovations seek to achieve sustainable development and cutting-edge performance.

LAMY RHEOLOGY is present in France and around the world to bring you the best solution to your expectations in the field of analytical measurement of your products.

In order to meet the demands of our customers worldwide, we rely on an extensive network of specialized and experienced resellers in the field of rheology.

So you can get our products in more than a hundred countries.

Our experience as well as our permanent internal development, allow us to meet the needs of customers in a very personalized way.

**The satisfaction of our customers has
always been our priority!**

67 years

of groundbreaking
first and innovative
thinking



Sophie



Eric



Aurélien



Camille



Julien



Sylvain



Chloé



Stanislas

RHEOLOGY

NEWS



CFR-21

The 21 CFR Part 11 standard is a regulation that defines the criteria for guaranteeing the reliability and authenticity of electronic records and signatures in the computerized systems of the pharmaceutical sectors regulated by the American FDA. It is only relevant for instruments connected to a computer and using software. The new RheoTex software is now offered with an option to make it compliant with this standard. Audit Trail, data protection, user management and electronic signatures are examples of the functions that we invite you to discover with our RheoTex software (p72-73).

CP-1000

The CP-1000 series instruments (FIRST PRODIG CP-1000 and RM 100 CP-1000) offer more possibilities than any other viscometer in the world. Equipped with the springless motor technology available from many years, they offer unequalled user-friendliness and modularity by integrating a support for cone-plane measurements and a space to install a beaker for the use of measuring mobiles such as MS-RV/LV, MS KREBS or MS VANE. Equipped with fluid circulation for temperature control, these instruments are also efficient when used alone or controlled by the RheoTex software. We invite you to discover the extended functions of the FIRST PRODIG CP-1000 (p16) and the incredible measurement range of the RM 100 CP-1000 (p20).



LIMS

A LIMS or Laboratory Information Management System is a type of software designed to improve laboratory productivity and efficiency, by tracking data associated with samples, experiments, laboratory workflows, and instruments. To allow a complete integration of these products, Lamy Rheology now integrates a LIMS function to its entire range (excepted B-ONE PLUS). Easy to use, the instruments automatically generate a file in selectable format (JSON, extended JSON, XML or ASCII) via the chosen connectivity (LAN).

SUM

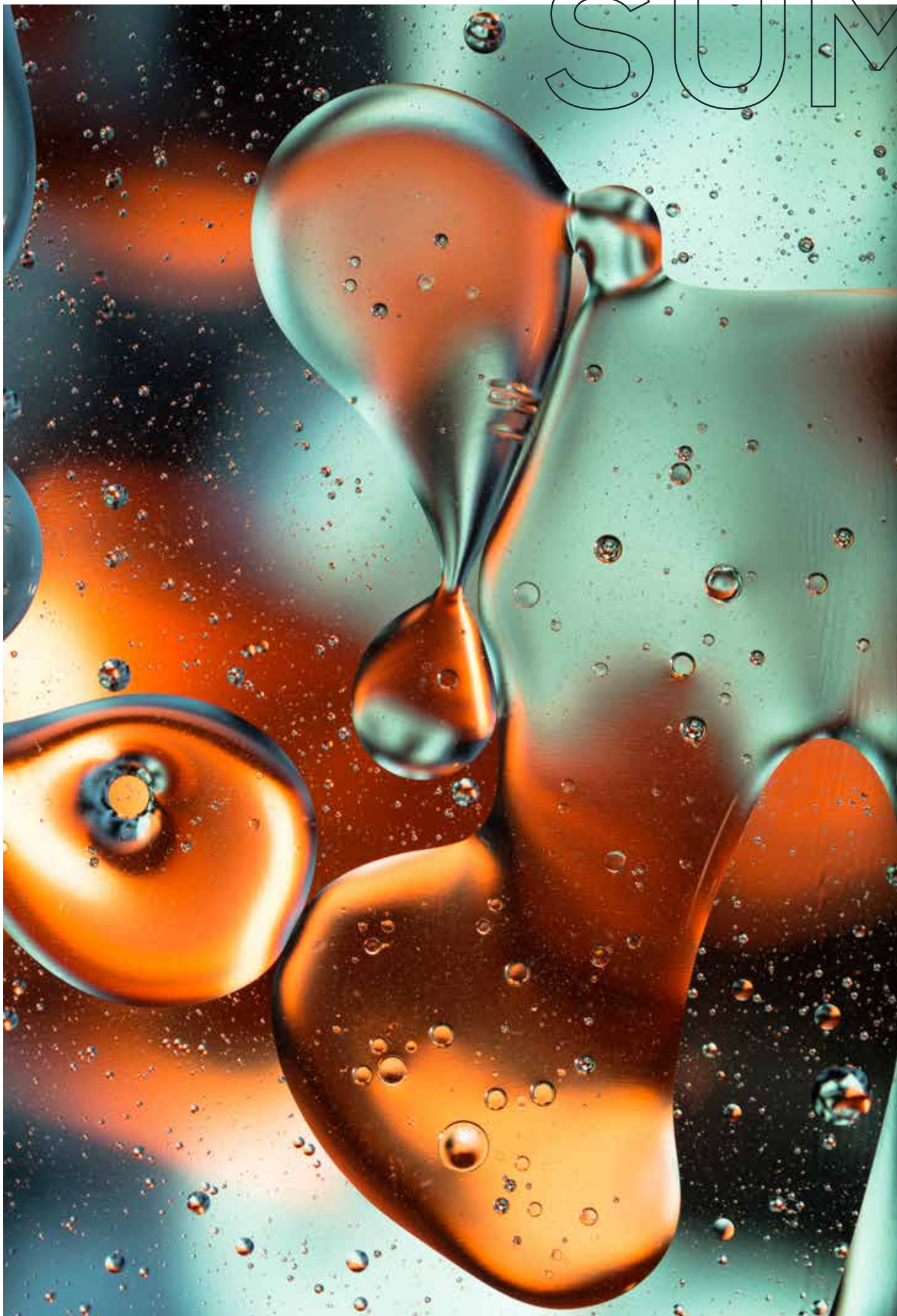

MARY

VISCOMETERS AND GELTIMERS

7

- 8 B-ONE PLUS
- 10 FIRST PLUS
- 12 FIRST PRO
- 14 FIRST PRODIG
- 16 FIRST PRODIG CP-1000
- 18 RM 100 PLUS
- 20 RM 100 CP-1000 PLUS
- 22 RM 100 CP-2000 PLUS
- 24 GT-300 PLUS
- 26 GT-300 PRODIG

PORTABLES AND INDUSTRIALS VISCOMETERS

29

- 30 PORTABLE B-ONE
- 32 PORTABLE RM 100
- 34 RM 100 i
- 36 RM 100 L

RHEOMETERS

39

- 40 RM 200 PLUS
- 42 RM 200 CP-4000 PLUS
- 44 DSR 500
- 46 DSR 500 CP-4000 PLUS

TEXTURE ANALYZERS

49

- 50 TX-700 - TX-900
- 52 PROBES
- 53 FIXTURES

TEMPERATURE CONTROLS

59

- 60 EVA MS-DIN / MS-R PLUS
- 61 EVA MS-R PLUS
- 62 EVA LR PLUS
- 63 RT-1 PLUS

OPTIONS & ACCESSORIES

65

- 66 HELIPRO
- 67 THERMOCELL PACKAGE
- 68 WATER JACKET
- 69 SMALL VOLUME PACKAGE
- 70 ACCESSORIES
- 72 RHEOTEX SOFTWARE

MEASURING SYSTEMS

75

- 76 MS-DIN
- 78 MS-R
- 79 MS-RV/LV
- 80 MS-BV
- 81 MS-VANES/MS-KREBS
- 82 MS-CHOCOLAT/MS-ULV
- 83 MS-SV
- 84 MS-CP
- 85 MS-PP

SERVICES AND SUPPORT

87

- 88 APPLICATIONS
- 89 TRAINING
- 90 CHECKING, CALIBRATION AND SERVICE
- 91 DISTRIBUTORS



VISCOMETERS AND GELTIMERS

VISCOMETERS AND GELTIMERS

SELECTION GUIDE CHOOSE YOUR INSTRUMENT:

● Standard | ○ Optional

FUNCTIONS	DEVICES									
	B-ONE PLUS	FIRST PLUS	FIRST PRO PLUS	FIRST PRODIG	FIRST PRODIG CP-1000	RM 100 PLUS	RM 100 CP-1000 PLUS	RM 100 CP-2000 PLUS	GT-300 PLUS	GT-300 PRODIG
7" TOUCH SCREEN	●	●	●	●	●	●	●	●	●	●
COUPLING	BAYONET	BAYONET	BAYONET	BAYONET	AC265	BAYONET	AC265	AC265	BAYONET	BAYONET
DATA/USER SECURITY	●	●	●	●	●	●	●	●	●	●
DATA MEMORISATION	●	●	●	●	●	●	●	●	●	●
DATA TRANSFER	●	●	●	●	●	●	●	●	●	●
MULTI LANGUAGES	●	●	●	●	●	●	●	●	●	●
VISCOSITY LIMITS	●	●	●	●	●	●	●	●	●	●
USB FLASH DRIVE PORT	●	●	●	●	●	●	●	●	●	●
TEMPERATURE PROBE	○	●	●	●	●	●	●	●	○	○
LIMS		●	●	●	●	●	●	●	●	●
USB/RS232 CONNECTION		●	●	●	●	●	●	●	●	●
PRINTER CONNECTION		●	●	●	●	●	●	●	●	●
RHEOTEX COMPATIBILITY		●	●	●	●	●	●	●	●	●
MANAGE TEMPERATURE UNIT			●	●	●	●	●	●	●	●
QC LIMITS			●	●	●	●	●	●	●	●
INBUILT SOFTWARE FOR PROGRAMMING			●	●	●	●	●	●	●	●
TIME TO STOP METHOD			●	●	●	●	●	●	●	●
MULTI INTERVAL METHOD			●	●	●	●	●	●		
RAMP METHOD				●	●					
DATA ANALYSIS				●	●					●
CURVE ON DISPLAY				●	●					●
PAGES	8	10	12	14	16	18	20	22	24	26

B-ONE PLUS

/ The economical solution
for your **viscosity**
measurements /



FEATURES AND BENEFITS

- Direct measure with time to stop.
- User and locked mode.
- Data recording and USB transfer.
- Torque gage on display.
- External temperature probe (option).
- Display of viscosity limits according to mobile and speed.
- Speed or shear rate control.

8



AVAILABLE INSTRUMENTS

Reference	Designation	Viscosity range (mPa.s)
N600000	B-ONE PLUS VISCOMETER WITH SPINDLES RV-2 TO RV-7 (with standard stand)	200 to 240M
N600200	B-ONE PLUS VISCOMETER WITH SPINDLE KU 1-10 (with standard stand)	40 to 140KU
N600009	B-ONE PLUS VISCOMETER WITH SPINDLES RV-2 TO RV-7 (with rack stand)	200 to 240M
N600300	B-ONE PLUS LR VISCOMETER WITH SPINDLES LV-1 TO LV-4 (with standard stand)	15(1*) to 22M
N600309	B-ONE PLUS LR VISCOMETER WITH SPINDLES LV-1 TO LV-4 (with rack stand)	15(1*) to 22M

M for million / (*) Can reach 1 mPa.s with MS ULV (p.82). Not included.



WHAT'S INCLUDED WITH DEVICE ? (according to part number)

4 Spindles LV or 6 spindles RV (p79) or Krebs spindle KU 1-10 (p81) / 1 Standard stand or rack stand (p70) / 1 Touch screen stylus / 1 User manual / 1 Calibration and checking certificate / 1 Microfiber cloth.

COMPATIBLES MEASURING SYSTEMS

MS-RV (p79), MS-LV (p79), MS-BV (p80),
MS-VANES (p81), MS-KREBS (p81),
MS-SV (p83), MS-ULV (p82), MS-DIN (p76).

COMPATIBLES TEMPERATURE CONTROLS

EVA LR (p62), EVA MS DIN (p60),
RT-1 PLUS (p63).

OPTIONS & ACCESSORIES

- Carrying case (p70).
- External temperature probe (p71).
- HELIPRO stand (p66).
- Barcode reader (p70).
- Bayonet spindle rack (p71).
- Touch screen protector (p70).
- Viscosity standards oil (p71).
- Small volume package (p68-69).
- THERMOCELL package (p67).
- GuardLeg (p71).

SPECIFICATIONS

Type of instrument

Rotating springless viscometer with 7" Touch screen

Rotation speeds

Unlimited number of speeds between 0.3 and 250 rpm

Torque range

Standard Version: 0.05 to 13 mNm
LR version: 0.005 to 0.8 mNm

Accuracy

+/- 1 % of the full scale

Repeatability

+/- 0,2 %

Display

Viscosity (cP / Poises or mPa.s / Pa.s)
Speed – Shear rate – Torque (% - mNm) –
Shear stress - Time – Temperature (in option)

Languages

French/English/Russian/Spanish/Turkish/
German/Italian

Supply voltage

90-240 VAC 50/60 Hz

Connection

USB port

Dimensions and weight

Head: D180 x H230 x W130 mm
Aluminium stand: L280 x W200 x H30 mm
Stainless steel rod: Length 500 mm
Weight: 6.7 kg



B-ONE PLUS
+ KU 1-10

FIRST PLUS

/ More than just a simple viscosity measurement /



FEATURES AND BENEFITS

- Direct measure with time to stop.
- User and locked mode.
- Data recording and USB transfer.
- Torque gage on display.
- Integrated temperature probe.
- Printer connection.
- Compatible with RheoTex software.
- Display of viscosity limits according to mobile and speed.
- Speed or shear rate control.
- LIMS function.

10



AVAILABLE INSTRUMENTS

Reference	Designation	Viscosity range (mPa.s)
N700700	FIRST PLUS VISCOMETER WITH SPINDLE RV-2 TO RV-7 (with standard stand)	200 to 240M
N700709	FIRST PLUS VISCOMETER WITH SPINDLE RV-2 TO RV-7 (with rack stand)	200 to 240M
N700300	FIRST PLUS LR VISCOMETER WITH SPINDLE LV-1 TO LV-4 (with standard stand)	15(1*) to 22M
N700009	FIRST PLUS LR VISCOMETER WITH SPINDLE LV-1 TO LV-4 (with rack stand)	15(1*) to 22M

M for million / (*) Can reach 1 mPa.s with MS ULV (p.82). Not included.



WHAT'S INCLUDED WITH DEVICE ? *(according to part number)*

4 Spindles LV or 6 spindles RV (p79) / 1 Integrated temperature probe / 1 Standard stand or rack stand (p70) / 1 Touch screen stylus / 1 User manual / 1 Calibration and checking certificate / 1 Microfiber cloth.

COMPATIBLES MEASURING SYSTEMS

MS-RV (p79), MS-LV (p79), MS-BV (p80),
MS-VANES (p81), MS-KREBS (p81),
MS-SV (p83), MS-ULV (p82), MS-DIN (p76).

COMPATIBLES TEMPERATURE CONTROLS

EVA LR (p62), EVA MS DIN (p60),
RT-1 PLUS (p63).

OPTIONS & ACCESSORIES

- Carrying case (p70).
- External temperature probe (p71).
- HELIPRO stand (p66).
- Barcode reader (p70).
- Bayonet spindle rack (p71).
- Touch screen protector (p70).
- Viscosity standards oil (p71).
- Dymo printer (p70).
- Small volume package (p68-69).
- THERMOCELL package (p67).
- RheoTex software (p72-73).
- GuardLeg (p71).



GUARDLEG LV
(Ref 000685)

SPECIFICATIONS

Type of instrument

Rotating springless viscometer with 7" Touch screen

Rotation speeds

Unlimited number of speeds between 0.3 and 250 rpm

Torque range

Standard Version: 0.05 to 13 mNm
LR version: 0.005 to 0.8 mNm

Temperature Probe

Equipped with a PT100 sensor which indicates temperatures between -50°C to +300°C

Accuracy

+/- 1 % of the full scale

Repeatability

+/- 0,2 %

Display

Viscosity (cP / Poises or mPa.s / Pa.s)
Speed – Shear rate – Torque (% - mNm) –
Shear stress - Time – Temperature

Languages

French/English/Russian/Spanish/Turkish/
German/Italian

Supply voltage

90-240 VAC 50/60 Hz

Analog output

4 – 20 mA

PC connections

RS232, USB and
Ethernet

Printer connection

USB Host Port -
Compatible PCL/5

Dimensions and weight

Head: D180 x H230 x W130 mm
Aluminium stand: L280 x W200 x H30 mm
Stainless steel rod: Length 500 mm
Weight: 6.7 kg

FIRST PRO

/ Programmed
for your measurements /



FEATURES AND BENEFITS

- Inbuilt software for programming.
- Direct measure with time to stop.
- User and locked mode.
- Data recording and USB transfer.
- Torque gage on display.
- Integrated temperature probe.
- Printer connection.
- Compatible with RheoTex software.
- Display of viscosity limits according to mobile and speed.
- Speed or shear rate control.
- Direct control of temperature unit.
- Multistep method.
- LIMS function.
- QC limits function.

12



AVAILABLE INSTRUMENTS

Reference	Designation	Viscosity range (mPa.s)
N702700	FIRST PRO VISCOMETER WITH SPINDLES RV-2 TO RV-7 (with standard stand)	200 to 240M
N702709	FIRST PRO VISCOMETER WITH SPINDLES RV-2 TO RV-7 (with rack stand)	200 to 240M
N702300	FIRST PRO LR VISCOMETER WITH SPINDLES LV-1 TO LV-4 (with standard stand)	15(1*) to 22M
N702309	FIRST PRO LR VISCOMETER WITH SPINDLES LV-1 TO LV-4 (with rack stand)	15(1*) to 22M

M for million / (*) Can reach 1 mPa.s with MS ULV (p.82). Not included.



WHAT'S INCLUDED WITH DEVICE ? (according to part number)

4 Spindles LV or 6 spindles RV (p79) / 1 Integrated temperature probe / 1 Standard stand or rack stand (p70) / 1 Touch screen stylus / 1 User manual / 1 Calibration and checking certificate / 1 Microfiber cloth.

 COMPATIBLES
MEASURING SYSTEMS

MS-RV (p79), MS-LV (p79), MS-BV (p80),
MS-VANES (p81), MS-KREBS (p81),
MS-SV (p83), MS-ULV (p82), MS-DIN (p76).

 COMPATIBLES
TEMPERATURE CONTROLS

EVA LR (p62), EVA MS DIN (p60),
RT-1 PLUS (p63).

 OPTIONS & ACCESSORIES

- Carrying case (p70).
- External temperature probe (p71).
- HELIPRO stand (p66).
- Barcode reader (p70).
- Bayonet spindle rack (p71).
- Touch screen protector (p70).
- Viscosity standards oil (p71).
- Dymo printer (p70).
- Small volume package (p68-69).
- THERMOCELL package (p67).
- RheoTex software (p72-73).
- GuardLeg (p71).

 SPECIFICATIONS

Type of instrument

Rotating springless viscometer with 7" Touch screen

Rotation speeds

Unlimited number of speeds between 0.3 and 250 rpm

Torque range

Standard Version: 0.05 to 13 mNm
LR Version: 0.005 to 0.8 mNm

Temperature Probe

Equipped with a PT100 sensor which indicates temperatures between -50°C to +300°C

Accuracy

+/- 1 % of the full scale

Repeatability

+/- 0,2 %

Display

Viscosity (cP / Poises or mPa.s / Pa.s)
Speed – Shear rate – Torque (% - mNm) –
Shear stress - Time – Temperature

Languages

French/English/Russian/Spanish/Turkish/
German/Italian

Supply voltage

90-240 VAC 50/60 Hz

Analog output

4 – 20 mA

PC connections

RS232, USB and
Ethernet

Printer

connection
USB Host Port -
Compatible PCL/5

Dimensions and weight

Head: D180 x H230 x W130 mm
Aluminium stand: L280 x W200 x H30 mm
Stainless steel rod: Length 500 mm
Weight: 6.7 kg

FIRST PRODIG

/ The solution
to your most
exacting methods. /

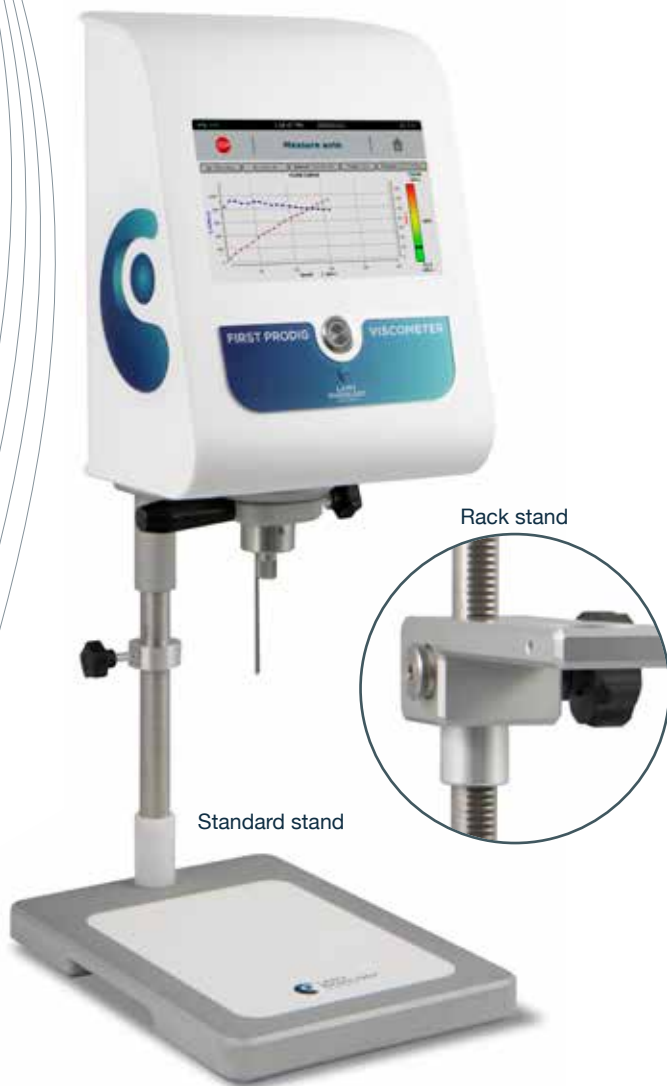

FEATURES AND BENEFITS

- Speed or shear rate control.
- Inbuilt software for programming.
- Constant, Multistep or ramp method.
- Direct curve on display.
- Direct analysis with regression.
- Direct report editing.
- Direct measure with time to stop.
- User and locked mode.
- Data recording and USB transfer.
- Torque gage on display.
- Integrated temperature probe.
- Printer connection.
- Compatible with RheoTex software.
- Display of viscosity limits according to mobile and speed.
- Direct control of temperature unit.
- LIMS function.
- QC limits function.

14

AVAILABLE INSTRUMENTS

Reference	Designation	Viscosity range (mPa.s)
N707700	FIRST PRODIG VISCOMETER WITH SPINDLES RV-2 TO RV-7 (with standard stand)	200 to 240M
N707709	FIRST PRODIG VISCOMETER WITH SPINDLES RV-2 TO RV-7 (with rack stand)	200 to 240M
N707300	FIRST PRODIG LR VISCOMETER WITH SPINDLES LV-1 TO LV-4 (with standard stand)	15(1*) to 22M
N707309	FIRST PRODIG LR VISCOMETER WITH SPINDLES LV-1 TO LV-4 (with rack stand)	15(1*) to 22M

M for million / (*) Can reach 1 mPa.s with MS ULV (p.82). Not included.

WHAT'S INCLUDED WITH DEVICE ? *(according to part number)*

4 Spindles LV or 6 spindles RV (p79) / 1 Integrated temperature probe / 1 Standard stand or rack stand (p70) / 1 Touch screen stylus / 1 User manual / 1 Calibration and checking certificate / 1 Microfiber cloth.

COMPATIBLES MEASURING SYSTEMS

MS-RV (p79), MS-LV (p79), MS-BV (p80),
MS-VANES (p81), MS-KREBS (p81),
MS-SV (p83), MS-ULV (p82), MS-DIN (p76).

COMPATIBLES TEMPERATURE CONTROLS

EVA LR (p62), EVA MS DIN (p60),
RT-1 PLUS (p63).

OPTIONS & ACCESSORIES

- Carrying case (p70).
- External temperature probe (p71).
- HELIPRO stand (p66).
- Barcode reader (p70).
- Bayonet spindle rack (p71).
- Touch screen protector (p70).
- Viscosity standards oil (p71).
- Dymo printer (p70).
- Small volume package (p68-69).
- THERMOCELL package (p67).
- RheoTex software (p72-73).
- GuardLeg (p71).

SPECIFICATIONS

Type of instrument

Rotating springless viscometer with 7" Touch screen

Rotation speeds

Unlimited number of speeds between 0.3 and 250 rpm

Torque range

Standard Version: 0.05 to 13 mNm
LR version: 0.005 to 0.8 mNm

Temperature Probe

Equipped with a PT100 sensor which indicates temperatures between -50°C to +300°C

Accuracy

+/- 1 % of the full scale

Repeatability

+/- 0,2 %

Display

Viscosity (cP / Poises or mPa.s / Pa.s)
Speed – Shear rate – Torque (% - mNm) –
Shear stress - Time – Temperature

Languages

French/English/Turkish/German/Italian

Supply voltage

90-240 VAC 50/60 Hz

Analog output

4 – 20 mA

PC connections

RS232, USB and
Ethernet

Printer connections

USB Host Port -
Compatible PCL/5

Dimensions and weight

Head: D160 x H270 x W200 mm
Aluminium stand: L280 x W200 x H30 mm
Stainless steel rod: Length 500 mm
Weight: 6.7 kg

FIRST PRODIG CP-1000

/ A revolution for measurements on low volumes. /

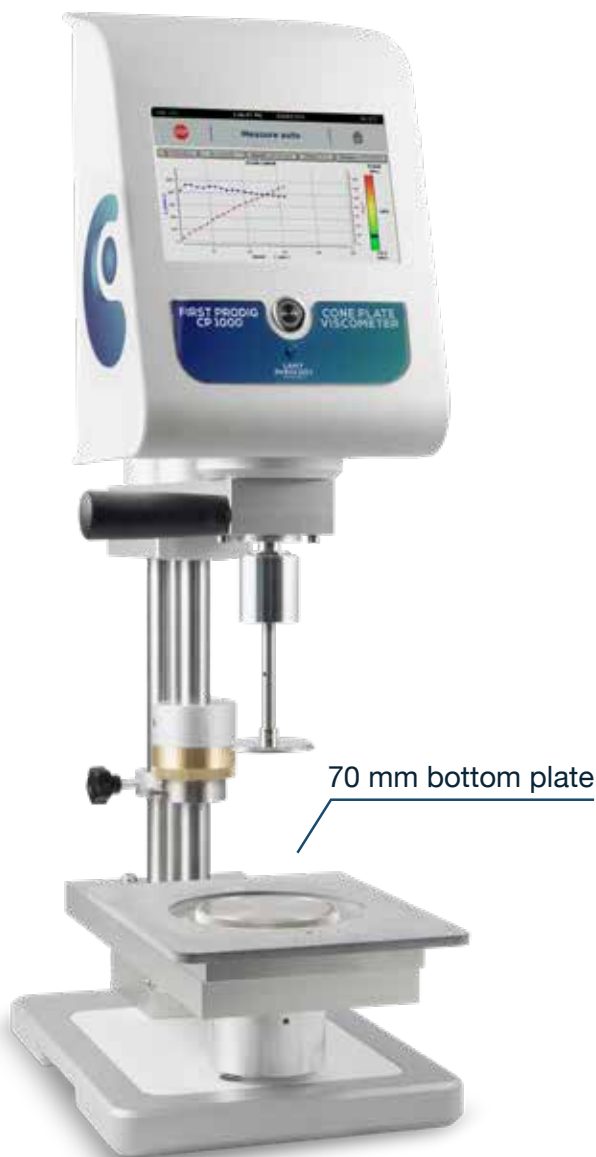

FEATURES AND BENEFITS

- CP-1000 stand for cone-plate measurement.
- Quick attachment with AC265 coupling.
- Manual lift for gap adjustment.
- Speed or shear rate control.
- Inbuilt software for programming.
- Constant, Multistep or ramp method.
- Direct curve on display.
- Direct analysis with regression.
- Direct report editing.
- Direct measure with time to stop.
- User and locked mode.
- Data recording and USB transfer.
- Torque gage on display.
- Integrated temperature probe.
- Printer connection.
- Compatible with RheoTex software.
- Display of viscosity limits according to mobile and speed.
- LIMS function.
- QC limits function.

16



AVAILABLE INSTRUMENT

Reference	Designation	Viscosity range (mPa.s)
N707500	FIRST PRODIG CP-1000 VISCOMETER (+5°C to +65°C)*	3 to 80M **

*M for million / * Maximum temperature range with circulating bath (not included). / ** According to cone-plate MS CP (p84). Not included.*



WHAT'S INCLUDED WITH DEVICE ? *(according to part number)*

- 1 Stand with 70mm bottom plate / 1 Double rod with stop ring and adjusting gap / 2 Silicon pipe (1m) / 1 Integrated temperature probe / 1 Touch screen stylus / 1 User manual / 1 Calibration and checking certificate / 1 Microfiber cloth. / 1 Adaptor bayonet-AC265 (Ref. 800146).

**COMPATIBLES
MEASURING SYSTEMS**

MS-CP (p84), MS-PP* (p85), MS-RV (p79),
MS-VANES (p81), MS-KREBS (p81)
(*with accessory 100047)

OPTIONS & ACCESSORIES

- Barcode reader (p70).
- Touch screen protector (p70).
- Viscosity standards oil (p71).
- Dymo printer (p70).
- RheoTex software (p72-73).
- Protection cover (Ref. 121019).

SPECIFICATIONS

Type of instrument

Rotating springless viscometer with 7" Touch screen

Rotation speeds

Unlimited number of speeds between 0.3 and 250 rpm

Torque range

From 0.05 to 13 mNm

Temperature Probe

Equipped with a PT100 sensor which indicates temperatures between -50°C to +300°C

Accuracy

+/- 1 % of the full scale

Repeatability

+/- 0,2 %

Display

Viscosity (cP / Poises or mPa.s / Pa.s)
Speed – Shear rate – Torque (% - mNm) –
Shear stress - Time – Temperature

Languages

French/English/Turkish/German/Italian

Supply voltag

90-240 VAC 50/60 Hz

Analog output

4 – 20 mA

PC connections

RS232, USB and Ethernet

Printer connection

USB Host Port - Compatible PCL/5

Dimensions and weight

D320 x H550 x W200 mm
Weight: 14 kg

FIRST PRODIG CP-1000
+ MK-VANE



RM 100 PLUS

/ Our most modular viscometer /



FEATURES AND BENEFITS

- Speed or shear rate control.
- Huge speed and torque range.
- Direct control of temperature unit.
- Inbuilt software for programming.
- Direct measure with time to stop.
- User and locked mode.
- Data recording and USB transfer.
- Torque gage on display.
- Integrated temperature probe.
- Printer connection.
- Compatible with RheoTex software.
- Display of viscosity limits according to mobile and speed.
- Multistep method.
- LIMS function.
- QC limits function.

18



AVAILABLE INSTRUMENTS

Reference	Designation	Viscosity range (mPa.s)
N100000	RM 100 PLUS VISCOMETER (with standard stand)	1 to 780M*
N100009	RM 100 PLUS VISCOMETER (with rack stand)	1 to 780M*

M for million / * According to measuring system (p76-83). Not Included.



WHAT'S INCLUDED WITH DEVICE ? (according to part number)

1 Integrated temperature probe / 1 Standard stand or rack stand (p70) / 1 Touch screen stylus / 1 User manual / 1 Calibration and checking certificate / 1 Microfiber cloth.

COMPATIBLES MEASURING SYSTEMS

MS-RV (p79), MS-LV (p79), MS-BV (p80),
MS-VANES (p81), MS-KREBS (p81), MS-SV
(p83), MS-ULV (p82), MS-DIN (p76), MS-R (p78).

COMPATIBLES TEMPERATURE CONTROLS

EVA LR (p62), EVA MS DIN (p60),
RT-1 PLUS (p63), EVA MS-R (p61).

OPTIONS & ACCESSORIES

- Carrying case (p70).
- External temperature probe (p71).
- HELIPRO stand (p66).
- Barcode reader (p70).
- Bayonet spindle rack (p71).
- Touch screen protector (p70).
- Viscosity standards oil (p71).
- Dymo printer (p70).
- Small volume package (p68-69).
- THERMOCELL package (p67).
- RheoTex software (p72-73).
- GuardLeg (p71).

SPECIFICATIONS

Type of instrument

Rotating springless viscometer with 7" Touch screen

Rotation speeds

Unlimited number of speeds between 0.3 and 1500 rpm

Torque range

From 0.05 to 30 mNm

Temperature Probe

Equipped with a PT100 sensor which indicates temperatures between -50°C to +300°C

Accuracy

+/- 1 % of the full scale

Repeatability

+/- 0,2%

Display

Viscosity (cP / Poises or mPa.s / Pa.s)
Speed – Shear rate – Torque (% - mNm) –
Shear stress - Time – Temperature

Languages

French/English/Russian/Spanish/Turkish/
German/Italian

Supply voltage

90-240 VAC 50/60 Hz

Analog output

4 - 20 mA

PC connections

RS232, USB and
Ethernet

Printer connection

USB Host Port -
Compatible PCL/5

Dimensions and weight

Head: D180 x H230 x W130 mm
Aluminium stand: L280 x W200 x H30 mm
Stainless steel rod: Length 500 mm
Weight: 6.7 kg

RM 100 CP-1000 PLUS

/ Cone plate viscometer for ICI method /



FEATURES AND BENEFITS

- CP-1000 stand for cone plate measurement.
- Quick attachment with AC265 coupling.
- Manual lift for gap adjustment.
- Speed or shear rate control.
- Inbuilt software for programming.
- Direct measure with time to stop.
- User and locked mode.
- Data recording and USB transfer.
- Torque gage on display.
- Integrated temperature probe.
- Printer connection.
- Compatible with RheoTex software.
- Display of viscosity limits according to mobile and speed.
- Multistep method.
- LIMS function.
- QC limits function.

20



AVAILABLE INSTRUMENT

Reference	Designation	Viscosity range (mPa.s)
N100365	RM 100 CP-1000 CONE PLATE VISCOMETER (+5°C to +65°C)*	1 to 190M **

M for million / * Maximum temperature range with water circulating bath (not included). / ** According to MS CP spindle (p84) not included.



WHAT'S INCLUDED WITH DEVICE ? (according to part number)

- 1 Stand with 70mm bottom plate / 1 Double rod with stop ring and adjusting gap / 2 Silicon pipe (1m) / 1 Integrated temperature probe / 1 Touch screen stylus / 1 User manual / 1 Calibration and checking certificate / 1 Microfiber cloth / 1 Adaptor bayonet-AC265 (Ref. 800146).

COMPATIBLES MEASURING SYSTEMS

MS-CP (p84), MS-PP* (p85), MS-RV (p79),
MS-VANES (p81), MS-KREBS (p81),
(*with accessory 100047)

OPTIONS & ACCESSORIES

- Barcode reader (p70).
- Touch screen protector (p70).
- Viscosity standards oil (p71).
- Dymo printer (p70).
- RheoTex software (p72-73).
- Protection cover (Ref. 121019).

SPECIFICATIONS

Type of instrument

Rotating springless viscometer with 7" Touch screen

Rotation speeds

Unlimited number of speeds between 0.3 and 1500 rpm

Torque range

From 0.05 to 30 mNm

Temperature Probe

Equipped with a PT100 sensor which indicates temperatures between -50°C to +300°C

Accuracy

+/- 1 % of the full scale

Repeatability

+/- 0,2 %

Display

Viscosity (cP / Poises or mPa.s / Pa.s)
Speed – Shear rate – Torque (% - mNm) –
Shear stress - Time – Temperature

Languages

French/English/Russian/Spanish/Turkish/
German/Italian

Supply voltage

90-240 VAC 50/60 Hz

Analog output

4 – 20 mA

PC connections

RS232, USB and
Ethernet

Printer connection

USB Host Port -
Compatible PCL/5

Dimensions and weight

D320 x H550 x W200 mm
Weight: 14 kg



RM 100 CP-1000
+ MS-KREBS

RM 100 CP-2000 PLUS

/ The viscometer dedicated for cone-plate measurements /

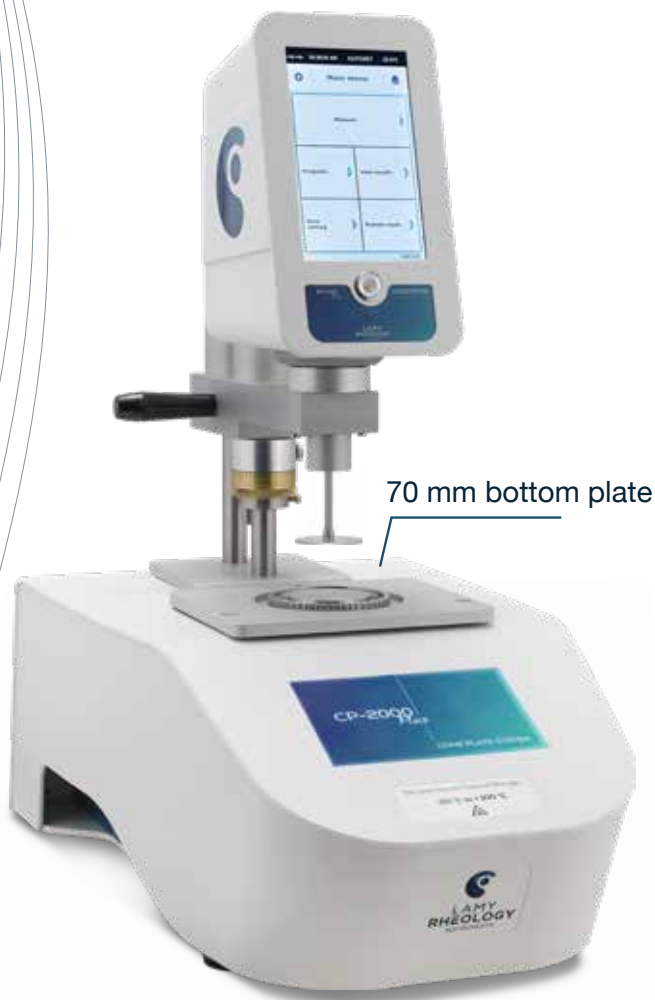

FEATURES AND BENEFITS

- For cone plate measurement.
- Quick attachment with AC265 coupling.
- Speed or shear rate control.
- Huge speed and torque range.
- Direct control of temperature unit.
- Inbuilt software for programming.
- Direct measure with time to stop.
- User and locked mode.
- Data recording and USB transfer.
- Torque gage on display.
- Integrated temperature probe.
- Printer connection.
- Compatible with RheoTex software.
- Display of viscosity limits according to mobile and speed.
- Multistep method.
- LIMS function.
- QC limits function.

22



AVAILABLE INSTRUMENTS

Reference	Designation	Viscosity range (mPa.s)
N170000	RM 100 CP-2000 PLUS VISCOMETER AIR PELTIER (+10°C to +70°C)	1 to 190M (according to spindles MS CP (p84))
N170100	RM 100 CP-2000 PLUS VISCOMETER AIR PELTIER (+10°C to +70°C) WITH PROGRAMMER*	
N170200	RM 100 CP-2000 PLUS VISCOMETER LIQUID PELTIER** (-20°C to +100°C)	
N170300	RM 100 CP-2000 PLUS VISCOMETER LIQUID PELTIER** (-20°C to +100°C) WITH PROGRAMMER*	
N170400	RM 100 CP-2000 PLUS VISCOMETER (Room T°C to +300°C)	
N170500	RM 100 CP-2000 PLUS VISCOMETER (Room T°C to +300°C) WITH PROGRAMMER*	
N170800	RM 100 CP-2000 PLUS VISCOMETER AIR PELTIER (0°C to +150°C)	
N170900	RM 100 CP-2000 PLUS VISCOMETER AIR PELTIER (0°C to +150°C) WITH PROGRAMMER*	

M for million / * Allow temperature setting by measuring head or RheoTex software. / ** Water circulating bath required. Not included.



WHAT'S INCLUDED WITH DEVICE ? (according to part number)

- 1 Temperature unit with 70mm bottom plate / 1 Touch screen stylus / 1 User manual / 1 Calibration and checking certificate / 1 Microfiber cloth.

COMPATIBLES MEASURING SYSTEMS

MS-CP (p84), MS-PP* (p85), (*with accessory
100047)

OPTIONS & ACCESSORIES

- Barcode reader (p70).
- Touch screen protector (p70).
- Viscosity standards oil (p71).
- Dymo printer (p70).
- RheoTex software (p72-73).
- Protection cover (Ref. 121019).



SPECIFICATIONS

Type of instrument

Rotating springless viscometer with 7" Touch screen

Rotation speeds

Unlimited number of speeds between 0.3 and 1500 rpm

Torque range

From 0.05 to 30 mNm

Temperature Probe

Equipped with a PT100 sensor which indicates temperatures between -50°C to +300°C

Accuracy

+/- 1 % of the full scale

Repeatability

+/- 0,2 %

Display

Viscosity (cP / Poises or mPa.s / Pa.s)
Speed – Shear rate – Torque (% - mNm) –
Shear stress - Time – Temperature

Languages

French/English/Russian/Spanish/Turkish/
German/Italian

Supply voltage

90-240 VAC 50/60 Hz

Analog output

4 – 20 mA

PC connections

RS232, USB and
Ethernet

Printer connection

USB Host Port -
Compatible PCL/5

Dimensions and weight

D610 x H700 x W340 mm
Weight: 22 kg

GT-300 PLUS

/ The ideal instrument
for your curing time /



FEATURES AND BENEFITS

- Inbuilt software for programming
- RheoTex software included.
- Direct control of temperature unit.
- Measure with disposable hooks and cups.
- Sample temperature probe (option).
- Low sample volume.
- Temperature ramp available.
- Display of viscosity limits according to mobile and speed.
- LIMS function.
- QC limits function.

24



AVAILABLE INSTRUMENTS

Reference	Designation
N125000	GT-300 GEL TIMER Room T°C
N125100	GT-300 GEL TIMER (Room T°C to +300°C)
N125200	GT-300 GEL TIMER (Room T°C to +300°C) WITH PROGRAMMER*
N125400	GT-300 GEL TIMER AIR PELTIER (+15°C to +60°C)
N125500	GT-300 GEL TIMER AIR PELTIER (+15°C to +60°C) WITH PROGRAMMER*
N125600	GT-300 GEL TIMER AIR PELTIER (0°C to +150°C)
N125700	GT-300 GEL TIMER AIR PELTIER (0°C to +150°C) WITH PROGRAMMER*

* Allow temperature setting by measuring head or RheoTex software.



WHAT'S INCLUDED WITH DEVICE ? *(according to part number)*

1 Holder for disposable hook / 1 Integrated temperature unit (Except item Ref. N125000) / 1 RheoTex software / 1 Touch screen stylus / 1 User manual / 1 Calibration and checking certificate / 1 Microfiber cloth.



OPTIONS & ACCESSORIES

- Barcode reader (p70).
- Touch screen protector (p70).
- Breakable Thermocouple 25 m type K (Complete kit with connector) (Ref. 000645).
- 100 Disposable cups aluminium (Ref. 700011).
- 100 Disposable steel hooks low volume (Ref. 700040).
- 100 Disposable stainless steel hooks (Ref. 700010).
- Protection cover (Ref. 310119).

Disposable cup
(aluminium)
(by 100)
Ref. 700011



Disposable hook
(stainless steel)
(Vol. 50-80mL)
(by 100)
Ref. 700010



Disposable hook
(steel)
(Vol. 35-50mL)
(by 100)
Ref. 700040



Ref. N125000
GT-300 GEL TIMER
ROOM T°
(with option Ref. 000645)



SPECIFICATIONS

Type of instrument

Rotating springless viscometer with 7" Touch screen

Rotation speeds

Unlimited number of speeds between 0.3 and 1500 rpm

Torque range

From 0.05 to 30 mNm

Temperature Probe

Equipped with a PT100 sensor which indicates temperatures between -50°C to +300°C

Accuracy

+/- 1 % of the full scale

Repeatability

+/- 0,2 %

Display

Viscosity (cP / Poises or mPa.s / Pa.s)
Speed – Shear rate – Torque (% - mNm) –
Shear stress - Time – Temperature

Languages

French/English/Russian/Spanish/Turkish/
German/Italian

Supply voltage

90-240 VAC 50/60 Hz

Analog output

4 - 20 mA

PC connections

RS232, USB and
Ethernet

Printer connections

USB Host Port -
Compatible PCL/5

Dimensions and weight

GT300 without temperature unit:
D320 x H650 x W200 mm. Weight: 14 kg

GT300 with temperature unit:
D610 x H700 x W340 mm. Weight: 22 kg

GT-300 PRODIG

/ Measure your Gel Time
on one click /



FEATURES AND BENEFITS

- Inbuilt software for programming.
- Direct curve on display.
- Direct Gel time analysis.
- Direct report editing.
- Direct control of temperature unit.
- Measure with disposable hooks and cups.
- Sample temperature probe (option).
- Low sample volume.
- Temperature ramp available.
- Display of viscosity limits according to mobile and speed.
- LIMS function.
- QC limits function.

26



AVAILABLE INSTRUMENTS

Reference	Designation
N129000	GT-300 PRODIG GEL TIMER Room T°C
N129100	GT-300 PRODIG GEL TIMER (Room T°C to +300°C)
N129200	GT-300 PRODIG GEL TIMER (Room T°C to +300°C) WITH PROGRAMMER*
N129400	GT-300 PRODIG GEL TIMER AIR PELTIER (+15°C to +60°C)
N129500	GT-300 PRODIG GEL TIMER AIR PELTIER (+15°C to +60°C) WITH PROGRAMMER*
N129600	GT-300 PRODIG GEL TIMER AIR PELTIER (0°C to +150°C)
N129700	GT-300 PRODIG GEL TIMER AIR PELTIER (0°C to +150°C) WITH PROGRAMMER*

* Allow temperature setting by measuring head or RheoTex software.



WHAT'S INCLUDED WITH DEVICE ? *(according to part number)*

1 Holder for disposable hook / 1 Integrated temperature unit (Except item Ref. N129000) / 1 Touch screen stylus / 1 User manual / 1 Calibration and checking certificate / 1 Microfiber cloth.

+ OPTIONS & ACCESSORIES

- Barcode reader (p70).
- Touch screen protector (p70).
- Breakable Thermocouple 25 m type K (Complete kit with connector) (Ref. 000645).
- 100 Disposable cups aluminium (Ref. 700011).
- 100 Disposable steel hooks low volume (Ref. 700040).
- 100 Disposable stainless steel hooks (Ref. 700010).
- RheoTex software (p72-73).
- Protection cover (Ref. 310119).

⚙️ SPECIFICATIONS

Type of instrument

Rotating springless viscometer with 7" Touch screen

Rotation speeds

Unlimited number of speeds between 0.3 and 1500 rpm

Torque range

From 0.05 to 30 mNm

Temperature Probe

Equipped with a PT100 sensor which indicates temperatures between -50°C to +300°C

Accuracy

+/- 1 % of the full scale

Repeatability

+/- 0,2 %

Display

Viscosity (cP / Poises or mPa.s / Pa.s)
Speed – Shear rate – Torque (% - mNm) –
Shear stress - Time – Temperature

Languages

French/English/Turkish/German/Italian

Supply voltage

90-240 VAC 50/60 Hz

Analog output

4 - 20 mA

PC connections

RS232, USB and Ethernet

Printer connection

USB Host Port - Compatible PCL/5

Dimensions and weight

GT300 PRODIG without temperature unit:
D320 x H650 x W200 mm. Weight: 14 kg

GT300 PRODIG with temperature unit:
D610 x H700 x W340 mm. Weight: 22 kg

Disposable cup
(aluminium)
(by 100)
Ref. 700011



Disposable hook
(stainless steel)
(Vol. 50-80mL)
(by 100)
Ref. 700010



Disposable hook
(steel)
(Vol. 35-50mL)
(by 100)
Ref. 700040

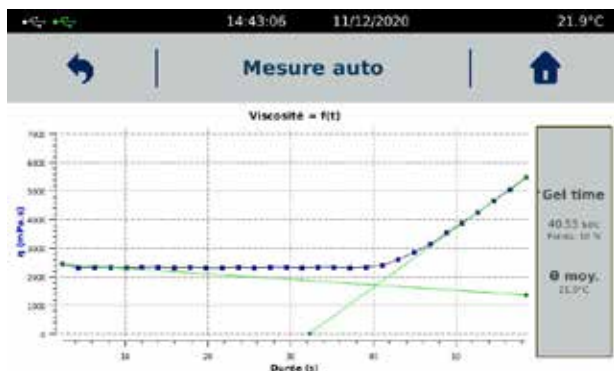

A microscopic view of plant cells, showing cell walls and internal structures, overlaid with a vibrant green color. The image is used as a background for a technical document.

PORTABLES AND INDUSTRIALS VISCOMETERS

PORTABLES AND INDUSTRIALS VISCOMETERS

SELECTION GUIDE

CHOOSE YOUR INSTRUMENT:

● Standard | ○ Optional

FUNCTIONS	DEVICES			
	PORTABLE B-ONE	PORTABLE RM 100	RM 100 i	RM 100 L
7" TOUCH SCREEN	●	●	●	●
COUPLING	BAYONET	BAYONET	BAYONET	SPECIAL
DATA/USER SECURITY	●	●	●	●
DATA MEMORISATION	●	●	●	●
DATA TRANSFER	●	●	●	●
MULTI LANGUAGES	●	●	●	●
VISCOSITY LIMITS	●	●	●	●
USB FLASH DRIVE PORT	●	●	●	●
TEMPERATURE PROBE	○	●	●	●
LIMS		●	●	●
USB/RS232 CONNECTION		●	●	●
PRINTER CONNECTION		●	●	●
RHEOTEX COMPATIBILITY		●	●	●
QC LIMITS		●	●	●
INBUILT SOFTWARE FOR PROGRAMMING		●	●	●
TIME TO STOP METHOD	●	●	●	●
MULTI INTERVAL METHOD		●	●	●
BATTERY MODE	●	●		
LARGE CONTAINER MEASUREMENT	●	●	●	
ONLINE MEASUREMENT				●
PAGES	30	32	34	36

PORTABLE B-ONE

/ This viscometer
follow you
everywhere /



FEATURES AND BENEFITS

- Autonomy more than one hour.
- Charge indicator.
- Direct measure with time to stop.
- Usable with standard or rack stand (option).
- User and locked mode.
- Data recording and USB transfer.
- Torque gage on display.
- Display of viscosity limits according to mobile and speed.
- Speed or shear rate control.

AVAILABLE INSTRUMENT

Reference	Designation	Viscosity range (mPa.s)
T600700	B-ONE PORTABLE VISCOMETER WITHOUT MEASURING SYSTEM	200(15**) to 240M*

M for million / * With MS-RV (RV2 to RV7) (p79). Not included. / ** Can reach 15 mPa.s with MS BV (p80).

WHAT'S INCLUDED WITH DEVICE ? *(according to part number)*

1 Carrying case (p70) / 1 Touch screen stylus / 1 User manual / 1 Calibration and checking certificate / 1 Microfiber cloth / 1 Harness.

COMPATIBLES MEASURING SYSTEMS

MS-RV (p79), MS-LV (p79), MS-BV (p80),
MS-VANES (p81), MS-KREBS (p81),
MS-SV (p83), MS-ULV (p82), MS-DIN (p76).

COMPATIBLES TEMPERATURE CONTROLS

EVA LR (p62), EVA MS DIN (p60),
RT-1 PLUS (p63).

OPTIONS & ACCESSORIES

- Standard or rack stand (p70).
- HELIPRO stand (p66).
- Small volume package (p68-69).
- THERMOCELL package (p67).
- Bayonet spindle rack (p71).
- Barcode reader (p70).
- Touch screen protector (p70).
- Viscosity standards oil (p71).

SPECIFICATIONS

Type of instrument

Rotating springless viscometer with 7" Touch screen

Rotation speeds

Unlimited number of speeds between 0.3 and 250 rpm

Torque range

From 0.05 to 13 mNm

Accuracy

+/- 1 % of the full scale

Repeatability

+/- 0,2 %

Display

Viscosity (cP / Poises or mPa.s / Pa.s)
Speed – Shear rate – Torque (% - mNm) –
Shear stress – Time

Languages

French/English/Russian/Spanish/Turkish/
German/Italian

Supply voltage

90-240 VAC 50/60 Hz

Dimensions et poids

Head : Ø 90 mm
Box D60 x H260 x W120
Weight: 2 kg



PORTABLE RM 100

/ Your expertise
closer to
the product /



FEATURES AND BENEFITS

- Autonomy more than one hour.
- Charge indicator.
- Huge speed and torque range.
- Usable with standard or rack stand (option).
- Inbuilt software for programming.
- Direct measure with time to stop.
- User and locked mode.
- Data recording and USB transfer.
- Torque gage on display.
- Integrated temperature probe.
- Printer connection.
- Compatible with RheoTex software.
- Display of viscosity limits according to mobile and speed.
- Speed or shear rate control.
- Multistep method.
- LIMS function.
- QC limits function

AVAILABLE INSTRUMENTS

Reference	Designation	Viscosity range (mPa.s)
T100100	RM 100 PORTABLE VISCOMETER WITHOUT MEASURING SYSTEM	200(1**) to 240M*

M for million / * With MS-RV (RV2 to RV7) (p79). Not included. / ** Can reach 1 mPa.s with MS DIN19 (p76).

WHAT'S INCLUDED WITH DEVICE ? *(according to part number)*

1 Integrated temperature probe / 1 Carrying case (p70) / 1 Touch screen stylus / 1 User manual.
1 Calibration and checking certificate / 1 Microfiber cloth / 1 Harness.

COMPATIBLES MEASURING SYSTEMS

MS-RV (p79), MS-LV (p79), MS-BV (p80),
MS-VANES (p81), MS-KREBS (p81), MS-SV (p83),
MS-ULV (p82), MS-DIN (p76), MS-R (p78).

COMPATIBLES TEMPERATURE CONTROLS

EVA LR (p62), EVA MS DIN (p60),
RT-1 PLUS (p63), EVA MS-R (p61).

OPTIONS & ACCESSORIES

- Standard or rack stand (p70).
- HELIPRO stand (p66).
- Small volume package (p68-69).
- THERMOCELL package (p67).
- Bayonet spindle rack (p71).
- Barcode reader (p70).
- Touch screen protector (p70).
- Viscosity standards oil (p71).
- Dymo printer (p70).
- RheoTex software (p72-73)



SPECIFICATIONS

Type of instrument

Rotating springless viscometer with 7" Touch screen

Rotation speeds

Unlimited number of speeds between 0.3 and 1500 rpm

Torque range

From 0.05 to 30 mNm

Temperature Probe

Equipped with a PT100 sensor which indicates temperatures between -50°C to +300°C

Accuracy

+/- 1 % of the full scale

Repeatability

+/- 0,2 %

Display

Viscosity (cP / Poises or mPa.s / Pa.s)
Speed – Shear rate – Torque (% - mNm) –
Shear stress - Time – Temperature

Languages

French/English/Russian/Spanish/Turkish/
German/Italian

Supply voltage

90-240 VAC 50/60 Hz

Analog output

4 – 20 mA

PC connections

RS232 Port and USB

Printer connection

USB Host Port -
Compatible PCL/5

Dimensions and weight

Head : Ø 90 mm
Box D60 x H260 x W120
Weight: 2 kg

RM 100 i

/ For viscosity measurement on large volume /



FEATURES AND BENEFITS



- Industrial measure on large tanker.
- Continuous measurement or with time to stop.
- 4-20 mA output.
- 17m maximum distance between head and box.
- Usable with standard or rack stand.
- Huge viscosity range.
- Inbuilt software for programming.
- External temperature probe (option).
- Printer connection.
- Compatible with RheoTex software.
- Display of viscosity limits according to mobile and speed.
- Speed or shear rate control.
- Multistep method.
- LIMS function.
- QC limits function

34



AVAILABLE INSTRUMENTS

Reference	Designation
T220200	RM 100 i IMMERSION INDUSTRIAL VISCOMETER
T220230	RM 100 i IMMERSION INDUSTRIAL VISCOMETER AC115
T220250	RM 100 i IMMERSION INDUSTRIAL VISCOMETER WITH PT100 SENSOR

Measuring systems not included.



WHAT'S INCLUDED WITH DEVICE ? *(according to part number)*

2m cable between measuring head and box / 1 Touch screen stylus / 1 User manual / 1 Calibration and checking certificate / 1 Microfiber cloth.

COMPATIBLES MEASURING SYSTEMS

MS-RV (p79), MS-LV (p79), MS-BV (p80),
MS-VANES (p81), MS-KREBS (p81), MS-SV (p83),
MS-ULV (p82), MS-DIN (p76), MS-R (p78).

COMPATIBLES TEMPERATURE CONTROLS

EVA LR (p62), EVA MS DIN (p60),
RT-1 PLUS (p63), EVA MS-R (p61).

OPTIONS & ACCESSORIES

- Standard or rack stand (p70).
- HELIPRO stand (p66).
- Small volume package (p68-69).
- THERMOCELL package (p67).
- Barcode reader (p70).
- Touch screen protector (p70).
- Viscosity standards oil (p71) .
- RheoTex software (p72-73).
- Cable extension 5 m (Ref. 113202) max 3 unit.

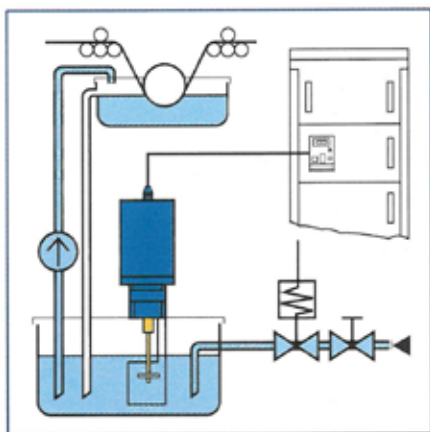

RM 100 i in use.

SPECIFICATIONS

Type of instrument

Rotating springless viscometer with 7" Touch screen

Rotation speeds

Unlimited number of speeds between 0.3 and 1500 rpm

Torque range

From 0.05 to 30 mNm

Accuracy

+/- 1 % of the full scale

Repeatability

+/- 0,2 %

Display

Viscosity (cP / Poises or mPa.s / Pa.s)
Speed – Shear rate – Torque (% - mNm) –
Shear stress - Time – Temperature

Application

The RM100 i is dedicated to tank measurements for continuous monitoring of viscosity in production. Its 4-20mA analogue output is used to send the measured value to a central computer. Numerous tailor-made solutions according to the customer configuration for integration into the process (length and height of the plungers, fixing on the cover of the measuring head with sealing,...).

Languages

French/English/Russian/Spanish/Turkish/
German/Italian

Supply voltage

90-240 VAC 50/60 Hz

Analog output

4 – 20 mA

PC connections

RS232, USB and
Ethernet

Printer connection

USB Host Port -
Compatible PCL/5

Dimensions and weight

Head : Ø 95 mm
Box D140 x H260 x W120
Weight: 3 kg

RM 100 L

/ The viscometer in line
with your process /



FEATURES AND BENEFITS

- Industrial on-line measurement.
- Continuous measurement or with time to stop.
- 4-20 mA output.
- Magnetic bearing for sealing.
- 30m maximum distance between head and box.
- Huge viscosity range.
- Inbuilt software for programming.
- External temperature probe (option).
- Printer connection.
- Compatible with RheoTex software.
- Display of viscosity limits according to mobile and speed.
- Speed or shear rate control.
- Multistep method.
- LIMS function.
- QC limits function

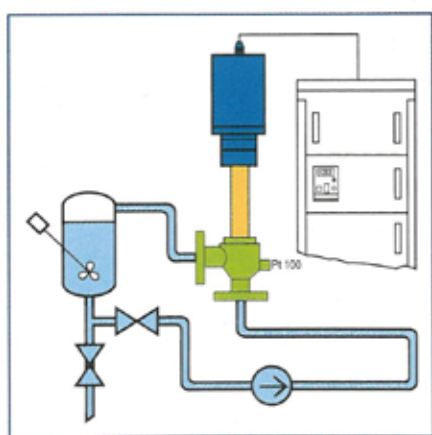

RM 100 L in use.



WHAT'S INCLUDED WITH DEVICE ? (according to part number)

15m cable between measuring head and box / 1 Touch screen stylus / 1 User manual / 1 Calibration and checking certificate / 1 Microfiber cloth.



OPTIONS & ACCESSORIES

- Touch screen protector (p70).
- Viscosity standards oil (p71).
- RheoTex software (p72-73).
- Cable extension 5 m (Ref. 113202) max 3 units.
- Measuring cylinder and cell (see table next page).

 SPECIFICATIONS

Type of instrument
Rotating springless viscometer with 7" Touch screen

Rotation speeds
Unlimited number of speeds between 5 and 600 rpm

Torque range
From 0.5 to 13 mNm

Accuracy +/- 1 % of the full scale	Repeatability +/- 0,2 %
--	-----------------------------------

Display
Viscosity (cP / Poises or mPa.s / Pa.s)
Speed – Shear rate – Torque (% - mNm) – Shear stress
- Time – Temperature

Application
The RM100 L is dedicated to on-line measurements for continuous monitoring of viscosity in production. Its 4-20mA analogue output is used to send the measured value to a central computer. Numerous tailor-made solutions according to customer configuration for process integration.

Languages
French/English/Russian/Spanish/Turkish/German/Italian

Supply voltage 90-240 VAC 50/60 Hz	Analog output 4 – 20 mA
PC connections RS232, USB and Ethernet	Printer connection USB Host Port - Compatible PCL/5

Dimensions and weight
Head : Ø 100 mm
Box D140 x H260 x W120
Weight: 4 kg

 AVAILABLE INSTRUMENTS

Viscometer delivered with electronic box and measuring chamber. Need to be ordered with cylinder and cell.

Designation viscometer	Reference viscometer	Compatible cylinder	Reference cylinder	Compatible cell*	Reference (cell)	SMS flange (mm)	Flow rate (m3/h)	Viscosity range (mPa.s)
RM 100 L Short	T220330	MS DIN 20-15	121065	CD25	121038	25	0.03 to 0.12	2.1k to 0.67M
				CD38	121057	38	0.05 to 0.5	
				CD50	121035	51	0.1 to 1	
				CD75	121034	76	0.5 to 2	
				LD75	121033	76	6 to 8	
				LD100	121032	104	10 to 14	
RM 100 L Standard	T220300 T220350 (with Fibox)	MS DIN 24	121036	CD25	121038	25	0.03 to 0.12	460 to 0.15M
				CD38	121057	38	0.05 to 0.5	
				CD50	121035	51	0.1 to 1	
				CD75	121034	76	0.5 to 2	
				LD75	121033	76	6 to 8	
				LD100	121032	104	10 to 14	
		MS DIN 30	121026	CD25	121038	25	0.03 to 0.12	113 to 35K
				CD38	121057	38	0.05 to 0.5	
				CD50	121035	51	0.1 to 1	
				CD75	121034	76	0.5 to 2	
				LD75	121033	76	6 to 8	
				LD100	121032	104	10 to 14	
RM 100 L Long	T220320	MS DIN 31.5	121060	LD100	121032	104	10 to 14	5 to 13K
				CD75	121034	76	0.5 to 2	

M for millions, K for thousand / * CD for bended cell and LD for straight cell.



RHEOMETERS

RHEOMETERS

SELECTION GUIDE

CHOOSE YOUR INSTRUMENT:

● Standard | ○ Optional

FUNCTIONS	DEVICES			
	RM 200 PLUS	RM 200 CP-4000 PLUS	DSR 500	DSR 500 CP-4000 PLUS
7" TOUCH SCREEN	●	●	●	●
COUPLING	BAYONET	AC265	BAYONET	AC265
DATA/USER SECURITY	●	●	●	●
DATA MEMORISATION	●	●	●	●
DATA TRANSFER	●	●	●	●
MULTI LANGUAGES	●	●	●	●
VISCOSITY LIMITS	●	●	●	●
USB FLASH DRIVE PORT	●	●	●	●
TEMPERATURE PROBE	●	●	●	●
LIMS	●	●	●	●
USB/RS232 CONNECTION	●	●	●	●
PRINTER CONNECTION	●	●	●	●
RHEOTEX COMPATIBILITY	●	●	●	●
MANAGE TEMPERATURE UNIT	●	●	●	●
QC LIMITS	●	●	●	●
INBUILT SOFTWARE FOR PROGRAMMING	●	●	●	●
TIME TO STOP METHOD	●	●	●	●
MULTI INTERVAL METHOD	●	●	●	●
RAMP METHOD	●	●	●	●
DATA ANALYSIS	●	●	●	●
CURVE ON DISPLAY			●	●
PAGES	40	42	44	46

RM 200 PLUS

/ The rheology
at your fingertips /



FEATURES AND BENEFITS

- Constant, Multistep or ramp method.
- Direct analysis with regressions.
- Direct control of temperature unit.
- Huge viscosity range.
- Speed or shear rate control.
- Inbuilt software for programming.
- Direct measure with time to stop.
- User and locked mode.
- Data recording and USB transfer.
- Torque gage on display.
- Integrated temperature probe.
- Printer connection.
- Compatible with RheoTex software.
- Display of viscosity limits according to mobile and speed.
- LIMS function.
- QC limits function.

AVAILABLE INSTRUMENTS

Reference	Designation	Viscosity range (mPa.s)
N200000	RM 200 PLUS RHEOMETER (with standard stand)	1 to 780M*
N200009	RM 200 PLUS RHEOMETER (with rack stand)	1 to 780M*

M for million / * According to measuring system (p76-83). Not included.

WHAT'S INCLUDED WITH DEVICE ? (according to part number)

1 Integrated temperature probe / 1 Standard stand or rack stand (p70) / 1 Touch screen stylus / 1 User manual / 1 Calibration and checking certificate / 1 Microfiber cloth.

 COMPATIBLES MEASURING SYSTEMS

MS-RV (p79), MS-LV (p79), MS-BV (p80),
MS-VANES (p81), MS-KREBS (p81), MS-SV
(p83), MS-ULV (p82), MS-DIN (p76), MS-R (p78).

 COMPATIBLES TEMPERATURE CONTROLS

EVA LR (p62), EVA MS DIN (p60),
RT-1 PLUS (p63), EVA MS-R (p61).

 OPTIONS & ACCESSORIES

- Carrying case (p70).
- External temperature probe (p71).
- HELIPRO stand (p66).
- Small volume package (p68-69).
- THERMOCELL package (p67).
- Bayonet spindle rack (p71).
- Barcode reader (p70).
- Touch screen protector (p70).
- Dymo printer (p70).
- Viscosity standards oil (p71).
- RheoTex software (p72-73).
- GuardLeg (p71).

 SPECIFICATIONS

Type of instrument

Rotating springless rheometer with 7" Touch screen

Rotation speeds

Unlimited number of speeds between 0.3 and 1500 rpm

Torque range

From 0.05 to 30 mNm

Temperature Probe

Equipped with a PT100 sensor which indicates temperatures between -50°C to +300°C

Accuracy

+/- 1 % of the full scale

Repeatability

+/- 0,2 %

Display

Viscosity (cP / Poises or mPa.s / Pa.s)
Speed – Shear rate – Torque (% - mNm) –
Shear stress - Time – Temperature

Languages

French/English/Russian/Spanish/Turkish/
German/Italian

Supply voltage

90-240 VAC 50/60 Hz

Analog output

4 – 20 mA

PC connections

RS232, USB and
Ethernet

Printer connection

USB Host Port -
Compatible PCL/5

What benefits are there for you?

Save your flow curves and calculate your rheological parameters directly without computer (Plastic viscosity, flow limit, regression model according to Newton, Bingham, Casson and Ostwald). Choose your attachment system tailored to your product constraints.

Dimensions and weight

Head: D180 x H230 x W130 mm
Aluminium stand: L280 x W200 x H30 mm
Stainless steel rod: Length 500 mm
Weight: 6.7 kg

RM 200 CP-4000 PLUS

/ Optimize your
rheological
measurements /



70 mm bottom plate



FEATURES AND BENEFITS

- Automatic lift for gap.
- Quick attachment with AC265 coupling.
- Constant, Multistep or ramp method.
- Direct analysis with regressions.
- Direct control of temperature unit.
- Huge viscosity range.
- Speed or shear rate control.
- Inbuilt software for programming.
- Direct measure with time to stop.
- User and locked mode.
- Data recording and USB transfer.
- Torque gage on display.
- Integrated temperature probe.
- Printer connection.
- Compatible with RheoTex software.
- Display of viscosity limits according to mobile and speed.
- LIMS function.
- QC limits function.



WHAT'S INCLUDED WITH DEVICE ?

(according to part number)

1 Temperature unit with 70mm bottom plate / 1 Touch screen stylus / 1 User manual / 1 Calibration and checking certificate / 1 Microfiber cloth.



OPTIONS & ACCESSORIES

- Barcode reader (p70).
- Touch screen protector (p70).
- Viscosity standards oil (p71).
- Dymo printer (p70).
- RheoTex software (p72-73).
- Protection cover (Ref. 121019).

 SPECIFICATIONS

Type of instrument

Rotating springless rheometer with 7" Touch screen

Rotation speeds

Unlimited number of speeds between 0.3 and 1500 rpm

Torque range

From 0.05 to 30 mNm

Temperature Probe

Equipped with a PT100 sensor which indicates temperatures between -50°C to +300°C

Accuracy

+/- 1 % of the full scale

Repeatability

+/- 0,2 %

Display

Viscosity (cP / Poises or mPa.s / Pa.s)
Speed – Shear rate – Torque (% - mNm) – Shear stress -
Time – Temperature

Languages

French/English/Russian/Spanish/Turkish/German/Italian

Supply voltage

90-240 VAC 50/60 Hz

Analog output

4 – 20 mA

PC connections

RS232, USB and Ethernet

Printer connection

USB Host Port -
Compatible PCL/5

What benefits are there for you?

Save your flow curves and calculate your rheological parameters directly without computer (Plastic viscosity, flow limit, regression model according to Newton, Bingham, Casson and Ostwald). Choose your attachment system tailored to your product constraints.

Dimensions and weight

D610 x H700 x W340 mm
Weight: 22 kg

 COMPATIBLES MEASURING SYSTEMS

MS-CP (p85), MS-PP (p85), MS-DIN (p76, only for models N240256 and N240257)

 AVAILABLE INSTRUMENTS

Reference	Designation	Viscosity range (mPa.s)
N240250	RM 200 CP-4000 PLUS RHEOMETER AIR PELTIER (+10°C to +70°C)	1 to 63,6M (according to spindles MS CP (p85))
N240251	RM 200 CP-4000 PLUS RHEOMETER AIR PELTIER (+10°C to +70°C) WITH PROGRAMMER*	
N240256	RM 200 CP-4000 PLUS RHEOMETER + CYL*** AIR PELTIER (+10°C to +70°C)	
N240257	RM 200 CP-4000 PLUS RHEOMETER + CYL*** AIR PELTIER (+10°C to +70°C) WITH PROGRAMMER*	
N240600	RM 200 CP-4000 PLUS RHEOMETER AIR PELTIER (0°C to +150°C)	
N240601	RM 200 CP-4000 PLUS RHEOMETER AIR PELTIER (0°C to +150°C) WITH PROGRAMMER*	
N240800	RM 200 CP-4000 PLUS RHEOMETER LIQUID PELTIER** (-20°C to +100°C)	
N240801	RM 200 CP-4000 PLUS RHEOMETER LIQUID PELTIER** (-20°C to +100°C) WITH PROGRAMMER*	
N240900	RM 200 CP-4000 PLUS RHEOMETER (Room T°C to +300°C)	
N240901	RM 200 CP-4000 PLUS RHEOMETER (Room T°C to +300°C) WITH PROGRAMMER*	

M for million / * Allow temperature setting by measuring head or RheoTex software. / ** Water circulating bath required. Not included. / *** Allow using of measuring systems as MS DIN 11S, 13S, 22S, 33S (p76), MS VANE (according to dimensions p81) and MS SV (p83).

DSR 500

/ A new vision on
your measurements /



FEATURES AND BENEFITS

- Direct curve on display.
- Shear rate and speed control.
- Constant, Multistep or ramp method.
- Direct analysis with regressions.
- Direct control of temperature unit.
- Huge viscosity range.
- Inbuilt software for programming.
- Direct measure with time to stop.
- User and locked mode.
- Data recording and USB transfer.
- Torque gage on display.
- Integrated temperature probe.
- Printer connection.
- Compatible with RheoTex software.
- Display of viscosity limits according to mobile and speed.
- LIMS function.
- QC limits function.



AVAILABLE INSTRUMENT

Reference	Designation	Viscosity range (mPa.s)
N500100	DSR 500 RHEOMETER	1 to 780M*

M for million / * According to measuring system (p76-83). Not included.



WHAT'S INCLUDED WITH DEVICE ? *(according to part number)*

1 Integrated temperature probe / 1 Standard stand (p70) / 1 Touch screen stylus / 1 User manual /
1 Calibration and checking certificate / 1 Microfiber cloth.

COMPATIBLES MEASURING SYSTEMS

MS-RV (p79), MS-LV (p79), MS-BV (p80),
MS-VANES (p81), MS-KREBS (p81), MS-SV
(p83), MS-ULV (p82), MS-DIN (p76), MS-R (p78).

COMPATIBLES TEMPERATURE CONTROLS

EVA LR (p62), EVA MS DIN (p60),
RT-1 PLUS (p63), EVA MS-R (p61).

OPTIONS & ACCESSORIES

- Carrying case (p70, only measuring head).
- HELIPRO stand (p66).
- Small volume package (p68-69).
- THERMOCELL package (p67).
- Barcode reader (p70).
- Bayonet spindle rack (p71).
- Touch screen protector (p70).
- Viscosity standards oil (p71).
- Dymo printer (p70).
- RheoTex software (p72-73).
- External temperature probe (p71).
- GuardLeg (p71).

SPECIFICATIONS

Type of instrument

Rotating springless rheometer with 7" Touch screen

Rotation speeds

Unlimited number of speeds between 0.3 and 1500 rpm

Torque range

From 0.05 to 30 mNm

Temperature Probe

Equipped with a PT100 sensor which indicates temperatures between -50°C to +300°C

Accuracy

+/- 1 % of the full scale

Repeatability

+/- 0,2 %

Display

Viscosity (cP / Poises or mPa.s / Pa.s)
Speed – Shear rate – Torque (% - mNm) –
Shear stress - Time – Temperature

Languages

French/English/Turkish/German/Italian

Supply voltage

90-240 VAC 50/60 Hz

Analog output

4 – 20 mA

PC connections

RS232, USB and
Ethernet

Printer connection

USB Host Port -
Compatible PCL/5

What benefits are there for you?

Memorize your flow ramps, draw your curves and calculate your rheological parameters directly without computer (plastic viscosity, flow limit and rheological models: Newton, Bingham, Casson, and Ostwald).
Edit your measurement reports directly on printer.

Dimensions and weight

Head: D160 x H270 x W200 mm
Aluminium stand: L280 x W200 x H30 mm
Stainless steel rod: Length 500 mm
Weight: 6.7 kg

DSR 500 CP-4000 PLUS

/ A rheometer
to meet
your requirements /



FEATURES AND BENEFITS

- Automatic lift for gap.
- Quick attachment with AC265 coupling.
- Direct curve on display.
- Shear rate and speed control.
- Constant, Multistep or ramp method.
- Direct analysis with regressions.
- Direct control of temperature unit.
- Huge viscosity range
- Inbuilt software for programming.
- Direct measure with time to stop.
- User and locked mode.
- Data recording and USB transfer.
- Torque gage on display.
- Integrated temperature probe.
- Printer connection.
- Compatible with RheoTex software.
- Display of viscosity limits according to mobile and speed.
- LIMS function.
- QC limits function.

AVAILABLE INSTRUMENTS

Reference	Designation	Viscosity range (mPa.s)
N500400	DSR 500 CP-4000 PLUS RHEOMETER AIR PELTIER (+10°C to +70°C)	1 to 63,6M (according to spindles MS CP (p85))
N500401	DSR 500 CP-4000 PLUS RHEOMETER AIR PELTIER (+10°C to +70°C) WITH PROGRAMMER*	
N500410	DSR 500 CP-4000 PLUS RHEOMETER AIR PELTIER (0°C to +150°C)	
N500411	DSR 500 CP-4000 PLUS RHEOMETER AIR PELTIER (0°C to +150°C) WITH PROGRAMMER*	
N500420	DSR 500 CP-4000 PLUS RHEOMETER LIQUID PELTIER** (-20°C to +100°C)	
N500421	DSR 500 CP-4000 PLUS RHEOMETER LIQUID PELTIER** (-20°C to +100°C) WITH PROGRAMMER*	
N500430	DSR 500 CP-4000 PLUS RHEOMETER (Room T°C to +300°C)	
N500431	DSR 500 CP-4000 PLUS RHEOMETER (Room T°C to +300°C) WITH PROGRAMMER*	
N500426	DSR 500 CP-4000 PLUS RHEOMETER + CYL*** AIR PELTIER (+10°C to +70°C) WITH PROGRAMMER*	
N500427	DSR 500 CP-4000 PLUS RHEOMETER + CYL*** AIR PELTIER (+10°C to +70°C)	

M for million / * Allow temperature setting by measuring head or RheoTex software. / ** Need a circulating water bath. Not included. / *** Allow using of measuring system MS DIN 11S, 13S, 22S, 33S (p76), MS VANE (according to dimensions p81) and MS SV (p83).

WHAT'S INCLUDED WITH DEVICE ? (according to part number)

1 Temperature unit with 70mm bottom plate / 1 Touch screen stylus / 1 User manual / 1 Calibration and checking certificate / 1 Microfiber cloth.

COMPATIBLES MEASURING SYSTEMS

MS-CP (p85), MS-PP (p85), MS-DIN (p76, only for models N500426 and N500427)

OPTIONS & ACCESSORIES

- Barcode reader (p70).
- Touch screen protector (p70).
- Viscosity standards oil (p71).
- Dymo printer (p70).
- RheoTex software (p72-73).
- Protection cover (Ref. 121019).

SPECIFICATIONS

Type of instrument

Rotating springless rheometer with 7" Touch screen

Rotation speeds

Unlimited number of speeds between 0.3 and 1500 rpm

Torque range

From 0.05 to 30 mNm

Temperature Probe

Equipped with a PT100 sensor which indicates temperatures between -50°C to +300°C

Accuracy

+/- 1 % of the full scale

Repeatability

+/- 0,2 %

Display

Viscosity (cP / Poises or mPa.s / Pa.s)
Speed – Shear rate – Torque (% - mNm) –
Shear stress - Time – Temperature

Languages

French/English/Turkish/German/Italian

Supply voltage

90-240 VAC 50/60 Hz

Analog output

4 – 20 mA

PC connections

RS232, USB and Ethernet

Printer connection

USB Host Port - Compatible PCL/5

What benefits are there for you?

Memorize your flow ramps, draw your curves and calculate your rheological parameters directly without computer (plastic viscosity, flow limit and rheological models: Newton, Bingham, Casson, and Ostwald). Edit your measurement reports directly on printer.

Dimensions and weight

D610 x H700 x W340 mm
Weight: 22 kg

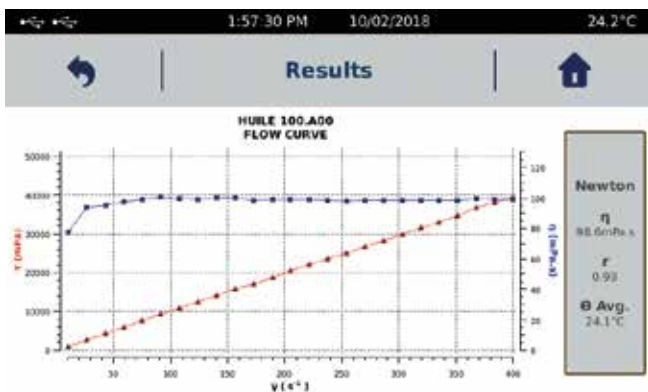



TEXTURE ANALYZERS

TEXTURE ANALYZERS

50 TX-700 - TX-900

52 PROBES

53 FIXTURES

AVAILABLE METHODS FOR OUR TEXTURE ANALYZERS:

METHODS	PROPERTIES	PROBES & FIXTURES	LOAD CELLS
COMPRESSION	Compressibility, compactability, springiness, relaxation, crush strength, firmness, elastic, work/load/deflection at rupture, maximum load.	Flat probes - Cylindrical probes (p52), TX-FCF (p54), TX-MOF - TX-UPFSF (p55), TX-CTPF (p56).	100N -250N -500N (p50-51).
PUNCTURE PENETRATION	Firmness, gel strength, dipping consistency, product toughness, fracture force, 'cake' breaking strength, semi-solid consistency, actuation force.	Cylindrical probes - ½ Spherical probes - Spherical probes - Needles - Conical probes (p52), TX-FCF - TX-SAF (p54), TX-MPF - TX-CPF - TX-AVJ (p56).	10N-20N-50N-100N-250N-500N (p50-51).
CUTTING SHEARING	Bite force, firmness, toughness, shear force.	Knife probe - Clever probe - Mesh probe (p52), TX-KFBF - TX-WSF - TX-ECF (p54), TX-VBJF - TX-MP - TX-STF -TX-WBF (p55), TX-TRPF (p56).	50N-100N-250N-500N (p50-51).
FRACTURE BENDING	Brittleness, snapping force, tip strength, flexibility, force to bend, bend modulus, fracture force, flexure modulus.	TX-TPBF - TX-FCF - TX-LCF (p54).	100N-250N-500N (p50-51).
TENSILE	Tensile strength, tensile 'break point', extensibility, stretchiness, elongation, burst point, tensile modulus, strength and strain to fracture, fracture toughness.	TX-FTF (p54), TX-PTF (p55), TX-KDEF - TX-RTF (p56), TX-RSF (p57).	10N-20N-50N-100N-250N-500N (p50-51).
ADHESION	Adhesiveness, stickiness, tackiness, peel force, cohesiveness, tailing, stringiness, legging, work of adhesion.	TX-FCF (p54), TX-UPFSF - TX-DSF (p55), TX-PF90 - TX-GPJF (p56), TX-MAF (p57).	10N-20N-50N-100N-250N-500N (p50-51).

TX-700 - TX-900

/ The **tactile**
texture analyzer /



FEATURES AND BENEFITS

- Integrated temperature probe.
- Direct curve on display.
- Inbuilt software for programming.
- Data recording and USB transfer.
- Many different probes and fixtures.
- Interchangeable load sensors.
- Height adjustable tray.
- Compatible with RheoTex software.
- LIMS function.

AVAILABLE INSTRUMENTS

TX-700	
Reference	Designation
N151010	TX-700 TEXTURE ANALYZER - 10N
N151020	TX-700 TEXTURE ANALYZER - 20N
N151050	TX-700 TEXTURE ANALYZER - 50N
N151100	TX-700 TEXTURE ANALYZER - 100N
N151250	TX-700 TEXTURE ANALYZER - 250N
N151500	TX-700 TEXTURE ANALYZER - 500N

TX-900	
Reference	Designation
N159010	TX-900 TEXTURE ANALYZER - 10N
N159020	TX-900 TEXTURE ANALYZER - 20N
N159050	TX-900 TEXTURE ANALYZER - 50N
N159100	TX-900 TEXTURE ANALYZER - 100N
N159250	TX-900 TEXTURE ANALYZER - 250N
N159500	TX-900 TEXTURE ANALYZER - 500N

WHAT'S INCLUDED WITH DEVICE ? *(according to part number)*

1 Interchangeable load sensor / 1 Temperature probe PT100 (-50°C à +300°C) / 1 Height adjustable tray / 1 User manual / 1 Calibration and checking certificate / 1 Microfiber cloth.

**SPECIFICATIONS****Type of device**

Texture Analyzer operating in Compression and Tensile with 7" Touch screen

Choice of sensors

10 N (1 kg), Resolution 0.001 N (0.1 g)
 20 N (2 kg), Resolution 0.001 N (0.1 g)
 50 N (5 kg), Resolution 0.001 N (0.1 g)
 100 N (10 kg), Resolution 0.001 N (0.1 g)
 250 N (25 kg), Resolution 0.01 N (1 g)
 500 N (50 kg), Resolution 0.01 N (1 g)

Accuracy

+/- 0.5 % of the full scale

Speed range

From 0.1 to 10 mm/s +/-0.2 %

Motion

TX-700 Travel : 200 mm - TX-900 Travel :
 400 mm / Resolution: 0.1 mm (0,01 mm with
 RheoTex)

Temperature Probe

Equipped with a PT100 sensor which indicates
 temperatures between -50°C to +300°C

Display

Strength – Speed – Distance – Temperature
 - Time – Measuring probe – Load sensor -
 Date/hour - Choice of strength units: gram or
 Newton

Languages

French/English/Turkish/German/Italian

Security and confidentiality

An «operator» function allows you to enter
 a username for your instrument. This user
 must then be identified using a 4-digit code.
 There is also a protected mode that locks your
 measurement conditions.

Supply voltage

90-240 VAC 50/60 Hz

PC connections

RS232 Port

Printer connection

USB Host Port -
 Compatible PCL/5

What benefits are there for you?

Integrated adjustable turntable: diam. 160 mm.
 Table for attaching inserts: 120 x 220 mm.
 Available Operating Modes: Compression
 – Relaxation –Tensile – TPA Cycle –
 Penetrometry and relative compression mode
 also. Large selection of probes available and
 custom probes can be made with choice of
 material, shape and size according to your
 criteria. The TX700 has a large 7" colour touch
 screen which allows comfortable use and
 optimal viewing of measurements. Storage of
 your measuring methods. Data can be backed
 up and exported using a USB stick. External
 control thanks to the optional software.

Dimensions and weight

TX-700: D610 x W340 x H710 mm. Weight: 25 kg
 TX-900: D610 x W340 x H970 mm. Weight: 27 kg



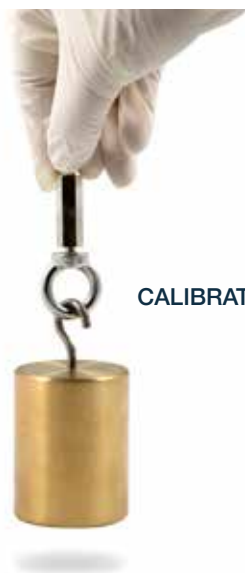







51

**OPTIONS & ACCESSORIES**

CALIBRATION KIT (p57)

- Probes (p52-53).
- Fixtures (p53-55).
- Barcode reader (p70).
- Touch screen protector (p70).
- Calibration Kit : 10-20N (Ref. 150060) ; 50-250N (Ref. 150070) ; 500N (Ref. 150080).
- RheoTex software (p72-73).
- Load sensor : 10N (Ref. N150010) ; 20N (Ref. N150020) ; 50N (Ref. N150050) ; 100N (Ref. N150100) ; 250N (Ref. N150250) ; 500N (Ref. N150500).
- Emergency stop button (Ref. 100700)







PROBES

Name / Material	Ref.	∅ (mm)	Height (mm)	Interest for	
1/2 SPHERICAL PROBE 316L Stainless Steel	130079 130174 130019 130049	8 16 30 40	-	Consistency, elasticity, adhesion and spinning on gel and cream.	
FLAT PROBE 316L Stainless Steel	130080 130083 130101 130175 130200 130177	34 40 50 75 100 160	-	Consistency, elasticity, adhesion and spinning on a solid of size smaller than the plateau.	
BLOOM PROBE plexiglass	130046	12.7	30	Bloom Gel Strength test	
CYLINDRICAL PROBE 316L Stainless Steel or Aluminium	130077 130063 130078 130066 130124 130099 130037 130176 130126	2 3 4 6 10 20 25 36 50	35 35 35 35 40 40 40 40 50	Measure in texture penetration on solid sample	
CONICAL PROBE 316L Stainless Steel	130020 130047 121023	25 30 30	20° Cône 45° Cône 30° Cône	Measurement in consistency penetration on solid sample (spreading)	
NEEDLE	130179	3	60	Core consistency	
CLEAVER PROBE 316L Stainless Steel	130064R	L. 25 mm	60° Angle	Breaking Force, Knack	
SPHERICAL PROBE 316L Stainless Steel	130191 130134 130149	12,7 19,5 20	-	Consistency, elasticity and adhesion on soft to strong sample	
MESH PROBE	130158R	50mm (adjustable)	-	Consistency of product with big particle as yogurt, sauce, jam.	
KNIFE PROBE	120012R	-	-	Cutting force.	

More size and material on request (Aluminium, PEEK, DELRIN, PMMA)

/ PROBES & FIXTURES SELECTION GUIDE /

FIXTURES

						
WARNER-BRATZLER FIXTURE (TX-WBF)	•	•				
WIRE SHEAR FIXTURE (TX-WSF)		•				
LIPSTICK CANTILEVER FIXTURE (TX-LCF)		•		•		
FILM COMPRESSION FIXTURE (TX-FCF)	•	•	•	•		
KRAMER 5 BLADES FIXTURE (TX-KFBF)	•	•				
3 POINTS BEND FIXTURE (TX-TPBF)	•	•				•
FILM TENSILE FIXTURE (TX-FTF)	•	•				
EXTRUSION FIXTURE (TX-ECF)	•	•	•	•	•	
SYRINGE ACTUATOR FIXTURE (TX-SAF)		•			•	
KIEFFER DOUGH EXTENSIBILITY FIXTURE (TX-KDEF)	•	•				
SLIDING FRICTION FIXTURE (TX-SFF)		•	•	•	•	
SPREAD TEST FIXTURE (TX-STF)	•	•			•	
MINI OTTAWA FIXTURE (TX-MOF)	•	•				
UNCOOKED PASTA FIRMNESS/STICKINESS FIXTURE (TX-UPFSF)	•	•				
VOLODKEVICH BITE JAWS FIXTURE (TX-VBJF)	•	•				
MOHRS PROBE (TX-MP)	•	•				
DOUGH STICKINESS FIXTURE (TX-DSF)	•	•				
PASTA TENSILE FIXTURE (TX-PTF)	•	•				
MULTIPLE PROBE FIXTURE (TX-MPF)	•	•				
THREE RINGS PROBE CUTTING (TX-TRPF)	•	•				
COMPRESSION TOP PLATE FIXTURE (TX-CTPF)	•	•			•	
CONFECTIONARY PENETRATION FIXTURE (TX-CPF)	•	•				
ADJUSTABLE VICE FIXTURE (TX-AVJ)	•	•			•	•
90° PEEL FIXTURE (TX-PF90)	•	•			•	
ROLLER TENSILE FIXTURE (TX-RTF)	•	•		•	•	
GENERAL PEELING JIG FIXTURE (TX-GPJF)	•	•		•	•	
RAFT STRENGTH FIXTURE (TX-RSF)		•		•	•	
MUCO ADHESION FIXTURE (TX-MAF)		•			•	
BLOOM PROBE (TX-BLM)	•	•		•	•	•
MESH PROBE (TX-MESH)	•	•				
KNIFE PROBE (TX-CKA)	•	•			•	•

FIXTURES

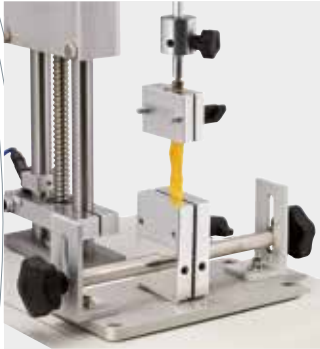

TX-FTF : FILM TENSILE FIXTURE
(Ref. 130092R)

Measure tensile strength of film.



TX-TPBF : 3 POINTS BEND FIXTURE
(Ref. 130091R)

Breaking strength, Friability, Springiness.



TX-KFBF : KRAMER 5 BLADES FIXTURE
(Ref. 130094R)

Hardness and tenderness on small samples (Requires table TX-FBT).



TX-FCF : FILM COMPRESSION FIXTURE
(Ref. 130031R)

Accessory to measure strength of film (Requires table TX-FBT).



TX-LCF : LIPSTICK CANTILEVER FIXTURE
(Ref. 130147R)

Accessory to measure strength of lipstick.



TX-WSF : WIRE SHEAR FIXTURE
(Ref. 130076R)

Accessory to measure consistency of product as Butter or Cheese.



TX-SAF : SYRINGE ACTUATOR FIXTURE
(Ref. 130145)

Study of needed strength to use syringe.

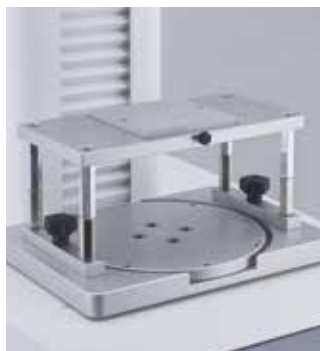

TX-FBT : FIXTURE BASE TABLE
(Ref. 310106R)

Universal holder for fixture and sample.



TX-ECF : EXTRUSION CELL FIXTURE
(Ref. 100200)

Forward and backward extrusion of liquid, cream, paste, gel (Requires table TX-FBT).

FIXTURES



**TX-MOF : MINI OTTAWA
FIXTURE**
(Ref. 130097)

Hardness and tenderness on
small samples.
(Requires table TX-FBT).



**TX-UPFSF : UNCOOKED
PASTA FIRMNESS/
STICKINESS FIXTURE**
(Ref. 130152R)

Firmness and stickiness of
uncooked pasta
(Requires table TX-FBT).



**TX-VBJF : VOLODKEVICH
BITE JAWS FIXTURE**
(Ref. 130068)

Shear cut and bite test.
(Requires table TX-FBT).



TX-MP : MOHRS PROBE
(Ref. 130165R)

Cutting test with blade
for meat, fish...
(Included 10 blades)



**TX-SFF : SLIDING
FRICTION FIXTURE**
(Ref. 120013R)

Friction measurement
according to ASTM D1894.



**TX-DSF : DOUGH
STICKINESS FIXTURE**
(Ref. 121017)

Measure of dough stickiness.
(Requires table TX-FBT).



**TX-PTF : PASTA TENSILE
FIXTURE**
(Ref. 130168R)

Measure of noodle
elasticity and rupture.



**TX-STF : SPREAD TEST
FIXTURE**
(Ref. 130157R)

Measure of the spreading ca-
pacity of creams, pastes
and gels.
(Requires table TX-FBT).



**TX-WBF :
WARNER-BRATZLER
FIXTURE**

(Ref. 130074R)
Cutting blade fine.
(Included 2 blades)

FIXTURES



TX-TRPF : THREE RINGS PROBE CUTTING FIXTURE
(Ref. 130186)

Measure firmness of sample as pasta, rice, corn...



TX-KDEF : KIEFFER DOUGH EXTENSIBILITY FIXTURE
(Ref. 130148)

Measure of dough elasticity and rupture
(Requires table TX-FBT).



TX-CTPF : COMPRESSION TOP PLATE FIXTURE
(Ref. 130153)

Measure firmness by uniform compression.
(Requires table TX-FBT).



TX-MPF : MULTIPLE PROBE FIXTURE
(Ref. 130170R)

Probe for puncture on 9 sample.
(Requires table TX-FBT).



TX-CPF : CONFECTIONARY PENETRATION FIXTURE
(Ref. 130190)

To hold small sample or candies while penetration test
(Requires table TX-FBT).

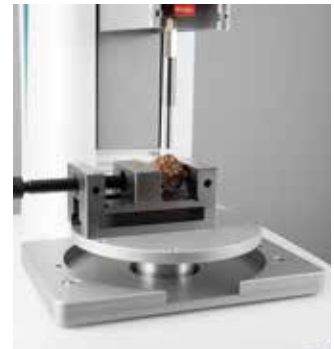

TX-AVJ : ADJUSTABLE VICE FIXTURE
(Ref. 130208)

To hold sample as vegetables, jelly or sweets for Puncture test.



TX-PF90 : 90° PEEL FIXTURE
(Ref. 130051R)

Measure adhesive strength to pull tape with angle 90°.



TX-RTF : ROLLER TENSILE FIXTURE
(Ref. 130194)

Measure tensile strength of fragile film thanks to grip of rollers.



TX-GPJF : GENERAL PEELING JIG FIXTURE
(Ref. 310105R)

Measure strength to remove lid from sealed container with angle 0°-45°-90°.



TX-RSF : RAFT STRENGTH FIXTURE
(Ref. 130021)

Measures strength to remove wire raft hook from sample.



TX-MAF : MUCO ADHESION FIXTURE
(Ref. 130181)

Measures natural adhesiveness between a tablet and a mucous membrane.

CALIBRATION KIT



10-20N (Ref. 150060)
50-250N (Ref. 150070)
500N (Ref. 150080).

8 PROBES KIT
(Ref. 130166)



Reference	Designation
121023	CONICAL PROBE 30°
130019	1/2 SPHERICAL PROBE DIAMETER 30 mm
130037	CYLINDRICAL PROBE H:40 mm Diam:25 mm
130064	CLEAVER PROBE 25 mm
130077	CYLINDRICAL PROBE DIAMETER 2 mm
130079	1/2 SPHERICAL PROBE DIAMETER 8 mm
130101	FLAT PROBE DIAMETER 50 mm
130124	CYLINDRICAL PROBE DIAMETER 10 mm

WE CAN ALSO MAKE CUSTOMISED PROBES AND FIXTURES ON REQUEST.

The background features a complex, fluid pattern of organic, smoke-like or liquid-like forms. The colors transition from deep purple and magenta at the top to vibrant cyan and teal at the bottom, with various shades of blue in between. The shapes are layered and overlapping, creating a sense of depth and movement.

TEMPERATURE CONTROLS

TEMPERATURE CONTROLS

- 60 EVA MS-DIN / MS-R PLUS
- 61 EVA MS-R PLUS
- 62 EVA LR PLUS
- 63 RT-1 PLUS

EVA MS-DIN/MS-R PLUS



FEATURES AND BENEFITS

- Temperature range -20°C to +150°C (according to model).
- Fast temperature regulation by Peltier element.
- Compatible with coaxial cylinders.
- Compatible with MS-R measuring system (according to model).

Chamber of EVA MS DIN/MS-R PLUS



60



AVAILABLE TEMPERATURE DEVICES

Compatible only with bayonet coupling device

Designation	Ref.	Temperature range	Type	Bath*	Prog***	Compatible instrument	Compatible measuring system	Dimensions (p x l x h) in mm	Weight
EVA MS DIN PLUS	N950000	+5°C to +65°C	Peltier	No	No	B-ONE FIRST RM100** RM200 DSR 500	MS DIN, MS SV, MS ULV, MS-Chocolat	610x340x650	15Kg
EVA MS DIN PLUS	N950005	+5°C to +65°C	Peltier	No	Yes				
EVA MS DIN PLUS	N950003	-20°C to +100°C	Peltier	Yes	No				
EVA MS DIN PLUS	N950012	-20°C to +100°C	Peltier	Yes	Yes				
EVA MS DIN PLUS	N950008	0°C to +150°C	Peltier	No	No				
EVA MS DIN PLUS	N950009	0°C to +150°C	Peltier	No	Yes				
EVA 100 PLUS	N950100	Room T°C to +100°C	Electrical	No	No				
EVA MS DIN/MS-R PLUS	N950002	+5°C to +65°C	Peltier	No	No	RM100** RM200 DSR 500	MS DIN, MS SV, MS ULV, MS-Chocolat, MS-R	610x340x650	15Kg
EVA MS DIN/MS-R PLUS	N950004	+5°C to +65°C	Peltier	No	Yes				
EVA MS DIN/MS-R PLUS	N950013	-20°C to +100°C	Peltier	Yes	No				
EVA MS DIN/MS-R PLUS	N950020	-20°C to +100°C	Peltier	Yes	Yes				
EVA MS DIN/MS-R PLUS	N950030	0°C to +150°C	Peltier	No	No				
EVA MS DIN/MS-R PLUS	N950040	0°C to +150°C	Peltier	No	Yes				

* Circulating bath not included. Required for counter cooling of Peltier. / ** Compatible with Portable RM100 and RM100 i. / *** Allow temperature setting by measuring head or RheoTex software.

EVA MS-R PLUS

FEATURES
AND BENEFITS

- Temperature range +12°C to +60°C.
- Can accommodate two instruments.
- Support for 9 simultaneous samples.



61



AVAILABLE TEMPERATURE DEVICES

Compatible only with bayonet coupling device (not compatible with B-ONE / FIRST).

Designation	Ref.	Temperature range	Type	Compatible instrument	Compatible measuring system	Dimensions (pxlxh) in mm	Weight
EVA MS-R PLUS 9 Holes	N950200	+17°C to +45°C	Peltier	RM 100* RM 200 DSR 500	MS-R	610x340x650	15kg
EVA MS-R PLUS 9 Holes	N950210	+12°C to +60°C	Peltier				

* Compatible with Portable RM100 and RM100 i.

EVA LR PLUS



FEATURES AND BENEFITS

- Temperature range +15°C to +45°C.
- Compatible with bayonet coupling device.
- Temperature setting of 600 ml beakers according to ISO 2555.



600 ml BEAKER

62



AVAILABLE TEMPERATURE DEVICE

Compatible with bayonet coupling device

Designation	Reference	Temperature range	Type	Compatible measuring system	Dimensions (p×l×h) in mm	Weight
EVA LR PLUS*	N950006	+15°C to +45°C	Peltier	MS RV-LV	610x340x650	15kg

* Usable with 600ml beaker.

RT-1 PLUS

FEATURES
AND BENEFITS

- Temperature range from Room T°C to +300°C.
- Economic electric oven.
- Compatible with bayonet coupling device.
- Compatible with norms ASTM D4402 and D3236.

63



AVAILABLE TEMPERATURE DEVICES

Compatible with bayonet coupling device

Designation	Reference	Temperature range	Type	Compatible measuring system	Dimensions (p×l×h) in mm	Weight
RT-1 PLUS + PROGRAMMER	N130130*	Room T°C to +300°C	Electrical	MS SV, MS DIN, MS ULV.	610x340x650	15kg
RT-1 PLUS	N130110	Room T°C to +300°C	Electrical			

* Allow temperature setting by measuring head or RheoTex software.



OPTIONS & ACCESSORIES

OPTIONS & ACCESSORIES

- 66 HELIPRO
- 67 THERMOCELL PACKAGE
- 68 WATER JACKET
- 69 SMALL VOLUME PACKAGE
- 70 ACCESSORIES
- 72 RHEOTEX SOFTWARE

HELIPRO

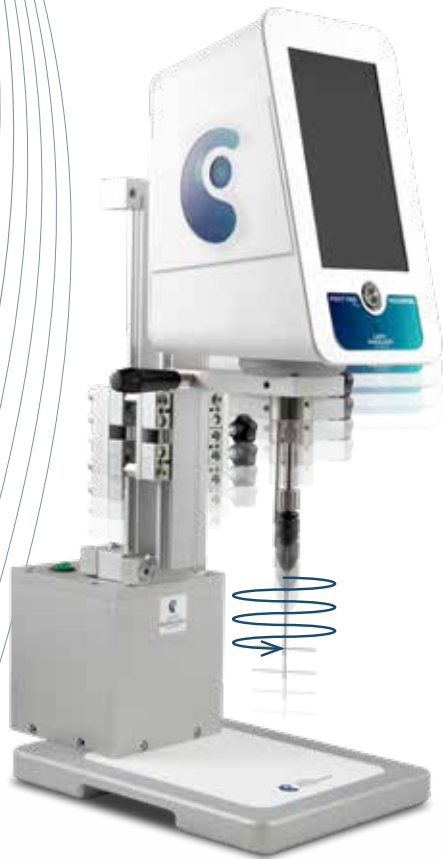

T-Bars spindles and holder



MEASURING SYSTEMS

T-bars spindles with viscosity range* (mPa.s)

Designation T-Bars**	Reference	Instrument LR		B-ONE AND FIRST		RM100, RM200, DSR500	
		Minimum	Maximum	Minimum	Maximum	Minimum	Maximum
T-A (91)	180091	93	740K	930	12M	930	28M
T-B (92)	180092	186	1.5M	1,9K	25M	1,9K	56M
T-C (93)	180093	464	3.7M	4,6K	60M	4,6K	140M
T-D (94)	180094	1K	7.5M	9,2K	120M	9,2K	280M
T-E (95)	180095	1,9K	15M	18,6K	240M	18,6K	558M
T-F (96)	180096	4,6K	37M	46,4K	600M	46,4K	1400M

M for million, K for thousand / * Viscosity value done for speed range from 0,3 to 15 rpm. / ** Included with HELIPRO package (Ref. 111015)

The HELIPRO device makes it possible to measure viscosity of gels, pastes, creams and more generally products that do not flowing.

When a measuring mobile turns in this type of product, we can observe appearance of cavities around the rotating spindle which has effect of reducing measured viscosity values. Through its movement vertical, HELIPRO system with its mobile T shape will prevent formation of cavities within product and will ensure reliable and consistent measurement.

This accessory is compatible with viscometers and rheometers from the LAMY RHEOLOGY range except FIRST PRODIG CP-1000, RM 100 CP-1000/2000 PLUS, RM 200 CP-4000 PLUS, GT-300 PLUS, GT-300 PRODIG and DSR 500 CP-4000 PLUS.



DIMENSIONS AND WEIGHT

D330 x W200 x H500mm
Weight 9Kg



WHAT'S INCLUDED WITH HELIPRO STAND ?

(Ref. 111015)

- 1 Stand with motorized lift.
- 1 Complete case (Ref. 950500) with 6 T-Bars (Ref. 180006) and holder (Ref. 200200).
- Tools for lift setting.

THERMOCELL PACKAGE



Immersion PT100 probe
(Ref 000696)



WHAT'S INCLUDED WITH THERMOCELL (Ref. N130150)

- A - Choice of one MK-SV spindle (p 83).
- B - Cup MB-SV13R (Ref. 116213).
- C - Holder H-SV13RD for disposable cup MB-SV13RD. (Ref. 116313).
- D - 5 Disposable cups MB-SV13RD (Ref. 116413 for 100pcs).
- E - Centring tool ST-R (Ref. 114436).
- RT-1 PLUS oven (Ref. N130130).



FEATURES AND BENEFITS

- Temperature range from Room T°C to +300°C.
- Economic electric oven.
- Compatible with bayonet coupling device.
- Compatible with norms ASTM D4402 and D3236.



OPTIONS & ACCESSORIES

- Immersion PT100 probe with holder (Ref. 000696)
- Lid for cup MB-SV13R (Ref. 130185)

A



B



C



D



E

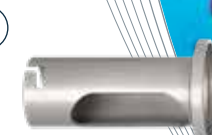

WATER JACKET



68

WATER JACKET CT-DIN

from -20°C to +180°C (Ref. 111914)
2 Silicon pipes 1m included



DIMENSIONS AND WEIGHT

Ø100 x H200 mm
Weight 3Kg

WATER JACKET CT-LC

from -20°C to +65°C (Ref. 600800)
2 Silicon pipes 1m included



DIMENSIONS AND WEIGHT

D70 x W70 x H160 mm
Weight 1,5Kg



COMPATIBLES MEASURING SYSTEMS

MS-DIN (p76), MS-VANES according to spindle (p81), MS-ULV (p82), MS-SV (p83).

SMALL VOLUME PACKAGE

Our "SMALL VOLUME PACKAGE" solutions guarantee you the possibility of measuring the viscosity on small quantities of sample. Easy to use and compatible with all our instruments (except FIRST PRODIG CP-1000, RM 100 CP-1000/2000 PLUS, RM 200 CP-4000 PLUS, GT-300 PLUS, GT-300 PRODIG and DSR 500 CP-4000 PLUS), these package include: One water jacket (CT-DIN or CT-LC), an MK-SV measuring spindle (p83), an MB-SV measuring chamber (p83) and the necessary accessories (centring piece and pipe). The use of a circulation bath (not supplied) is necessary for temperature control. The MK-SV mobile and the MB-SV chamber must be indicated when ordering the low volume kit.

SMALL VOLUME PACKAGE SVP 180

(Ref. 600950)

Temperature range : -20°C to +180°C
(with circulation bath not included)

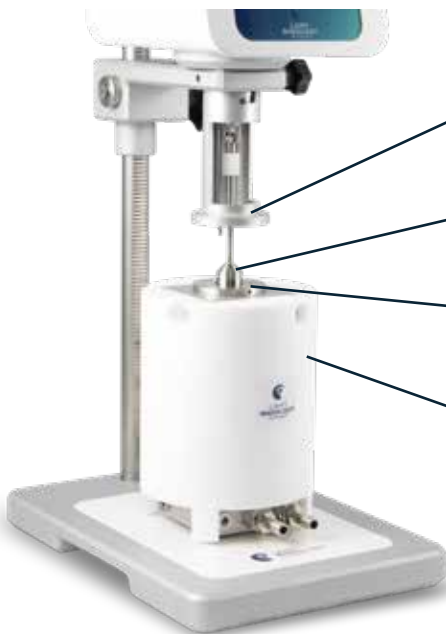

SMALL VOLUME PACKAGE SVP 65

(Ref. 600900)

Temperature range : -20°C to +65°C
(with circulation bath not included)



- Centring tool ST-R
- One spindle MK-SV
- One chamber MB-SV
- Water jacket

WHAT'S INCLUDED WITH PACKAGE

- Water Jacket CT-DIN (Ref. 111914).
- Centring tool ST-R (Ref. 114436).
- 2 Silicon pipes (1m).
- One spindle MK-SV (choose page 83).
- One chamber MB-SV (choose page 83)

WHAT'S INCLUDED WITH PACKAGE

- Water Jacket CT-LC (Ref. 600800).
- Centring tool ST-R (Ref. 114436).
- 2 Silicon pipes (1m).
- One spindle MK-SV (choose page 83).
- One chamber MB-SV (choose page 83)

ACCESSORIES

BARCODE READER (Ref. N330000)



This barcode reader allows you to quickly identify your sample without risk of data entry errors. It is compatible with all instruments in the LAMY RHEOLOGY range thanks to their USB port and with RHEOTEX software when connected to the computer. Included USB cable and holder.

ZEBRA LABEL PRINTER (Ref. 500220) + paper roll (Ref. 500221)



This ZEBRA printer can be connected to all compatible instruments (except B-ONE PLUS and B-ONE PORTABLE viscometer). It allows rapid printing at the end of measurement or at time intervals set by user while measurement. USB cable supplied and roll of paper.

STANDARD STAND (Ref. 112950)



The standard stand allows you to install your LAMY RHEOLOGY viscometer or rheometer on table. Thanks to its stop ring, it is recommended when the height of the measurement position is constant. Included according to instrument model, it includes a rod, a stop ring, a safety sleeve, a arm and a base.

RACK STAND (Ref. P008000)



The rack stand allows you to install your LAMY RHEOLOGY viscometer or rheometer on table. Thanks to its notched rod system, it allows easy vertical movement of measuring head and is recommended when height of measuring position varies according to container or measuring spindle used. Included according to instrument models, it includes a notched shank, arm and base.

TOUCH SCREEN PROTECTOR (Ref. 000630)



The screen protector provides permanent protection for touch screen of instruments in the LAMY RHEOLOGY range. It is effective against projections and dust while ensuring ease of use.

CARRYING CASE (Ref. 100048) or without foam (Ref. 100500)



If you want to transport or store your instrument, we offer this robust transport case suitable for your viscometer or rheometer. A space is dedicated for storage of accessories such as supports or measuring systems.

ACCESSORIES

VISCOSITY STANDARD OIL



Our viscosity standard oils allow you to verify the correct measurement made by your instrument. The choice of oil must be made according to viscosity range of products measured and required volume (e.g. 500ml for MS RV or MS LV mobiles or 100 ml for MS DIN or MS SV mobiles). They are delivered with a certificate established by LAMY RHEOLOGY. Other standard oils for high temperature measurements or supplied with NIST certificate are available on demand.

Reference	Volume and viscosity value at 23°C
260100	Standard Silicone Oil 100 mPas (100 ml)
261000	Standard Silicone Oil 1000 mPas (100 ml)
265500	Standard Silicone Oil 3500 mPa.s (100 ml)
260005	Standard Silicone Oil 5 mPas (100 ml)
260050	Standard Silicone Oil 50 mPas (100 ml)
260500	Standard Silicone Oil 500 mPas (100 ml)
265000	Standard Silicone Oil 5000 mPa.s (100 ml)
250100	Standard Silicone Oil 100 mPas (250ml)
251000	Standard Silicone Oil 1000 mPas (250ml)
250055	Standard Silicone Oil 5 mPas (250ml)
250050	Standard Silicone Oil 50 mPas (250ml)
250500	Standard Silicone Oil 500 mPas (250ml)
255000	Standard Silicone Oil 5000 mPa.s (250ml)
500100	Standard Silicone Oil 100 mPas (500ml)
501000	Standard Silicone Oil 1000 mPas (500ml)
500005	Standard Silicone Oil 5 mPas (500ml)
500050	Standard Silicone Oil 50 mPas (500ml)
500500	Standard Silicone Oil 500 mPas (500ml)
505000	Standard Silicone Oil 5000 mPa.s (500ml)

BAYONET SPINDLE RACK

(Ref. 000590)



This rack allows you to store in complete safety and near your instrument all the spindles having a bayonet coupling such as MS DIN, MS SV, MS-R, MS ULV, MS Krebs, MS Chocolat, MS VANE, MS RV and MS LR.

EXTERNAL TEMPERATURE PROBE WITH HOLDER

(Ref. 900026 and 405000)



This temperature probe can be connected to viscometers and rheometers of LAMY RHEOLOGY range and is particularly well suited for B-ONE PLUS and B-ONE PORTABLE viscometers.

GUARDLEG LV

(Ref. 000685)



Allows correct positioning of MS-LV spindles in 600ml beakers for optimized viscosity measurement.

GUARDLEG RV

(Ref. 000686)



Allows correct positioning of MS-RV spindles in 600ml beakers for optimized viscosity measurement.

SOFTWARE

The new RheoTex software developed by LAMY RHEOLOGY allows control of all instruments (excepted : B-ONE PLUS)

The license file associated with the software allows you to automatically configure software to be compatible with instrument. Since the software base is the same, only an additional license is required when you have two devices to control by RheoTex. The installation of the software is not limited to one computer station.

The integrity of results and methods is guaranteed by using a database and by an optimized management of the users with specific rights.

New graphical tools allow custom management of the display of curves, tables and analysis results.

The 21 CFR option is available in two versions :

- Standard for only one approval electronic signature.
- Advanced for three level of electronic signature : Done-Review-Approval.



FEATURES AND BENEFITS

- Creation and saving of methods.
- Transfer data from device memory.
- Temperature ramp method.
- Use of mathematical tools for data analysis.
- Creation of free program.
- PDF report editing.
- Compatible with office software or experience creation (automatic measurement and analysis).
- 21 CFR Part 11 Compatible.

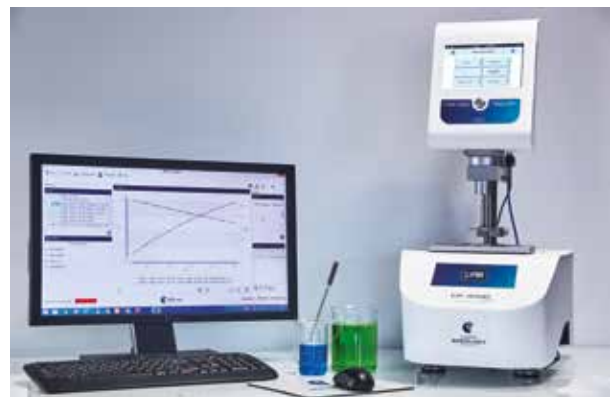

SOFTWARE



AVAILABLE CONFIGURATIONS

RheoTex for
FIRST PLUS/FIRST PRO
Ref. N311000 +
license **Ref. N311700**

RheoTex for
GT300 PLUS
Ref. N311000 +
license **Ref. N311300**

RheoTex for
DSR 500
Ref. N311000 +
license **Ref. N311500**

RheoTex for
RM100 PLUS, RM100 PORTABLE,
RM100i, RM100L, RM 100 CP 1000
Ref. N311000 + license **Ref. N311100**

RheoTex for
RM200 PLUS
Ref. N311000 +
license **Ref. N311200**

RheoTex for
DSR 500 CP 4000 PLUS
Ref. N311000 +
license **Ref. N311504**

RheoTex for
RM100 CP 2000 PLUS
Ref. 311000 +
license **Ref. N311202**

RheoTex for
RM200 CP 4000 PLUS
Ref. N311000 +
license **Ref. N311204**

RheoTex for
TX-700
Ref. N311000 +
license **Ref. N311777**

RheoTex for
GT300 PRODIG
Ref. N311000 +
license **Ref. N311310**

RheoTex for
FIRST PRODIG,
FIRST PRODIG CP 1000
Ref. N311000 + license
Ref. N311710

21 CFR option
Standard **Ref. N311020**
Advanced **Ref. N311021**



RHEOTEX FUNCTIONS ACCORDING TO INSTRUMENTS

Functions / Instrument version	FIRST	FIRST PRO	FIRST PRODIG	RM 100	RM 200	DSR 500	GT300	GT300 PRODIG	TX-700
Instrument connection	USB, RS232								RS232
Method viscosity over time	*	*	*	*	*	*	*	*	
Method step by step	*	*	*	*	*	*			
Method flow curve			*		*	*			
Methods Compression, Relaxation, Tensile, TPA, Penetrometry									*
Methods Free Program	*	*	*	*	*	*	*	*	*
Loop mode	*	*	*	*	*	*	*	*	*
Experiment	*	*	*	*	*	*	*	*	*
Logarithmic ramp			*		*	*			
Control of temperature unit (EVA, RT, CP1, CP2000, CP4000)*		*	*	*	*	*	*	*	
Data transfer from device memory	*	*	*	*	*	*	*	*	*
Direct curve while test	*	*	*	*	*	*	*	*	*
Import methods and results	*	*	*	*	*	*	*	*	*
Export/copy data to Office	*	*	*	*	*	*	*	*	*
Export/copy diagram to Office	*	*	*	*	*	*	*	*	*
Editing report pdf	*	*	*	*	*	*	*	*	*
Display multiple curves	*	*	*	*	*	*	*	*	*
Lift control					For CP4000				*
Role/user management	*	*	*	*	*	*	*	*	*
21 CFR Part 11	*	*	*	*	*	*	*	*	*
Automatic stop on measured value	*	*	*	*	*	*	*	*	*
Mathematic analysis of results	Maximum, minimum, average, curves average, smoothing, interpolation, inflexion								
Analysis as Area, Slope, TPA, relaxation									*
Rheological models	Newton, Ostwald, Bingham, Casson, Casson-Steiner, Chocolat				Newton, Ostwald, Bingham, Casson, Power Law, Herschel-Bulkley, Casson-Steiner, Steiger Ory, Chocolat				

* Only for temperature unit with programmer.



MEASURING SYSTEMS

MEASURING SYSTEMS















SELECTION GUIDE CHOOSE YOUR MEASURING SYSTEMS:

Sample type	Measuring systems								
	MS-RV/LV	MS-DIN	MS-SV	MS-CP	MS-PP	MS-R	MS-VANES	MS-BV	MS-KREBS
Low viscosity (solid particles < 10µm) ex : Paint, inks, shampoo, oil, lotion, drinks...	●	●	●	●	●			●	●
Low viscosity (solid particles > 10µm) ex : Paint, inks, suspension, chocolate...	●	●	●		●	●	●	●	●
Medium viscosity (solid particles < 10µm) ex : Cosmetic cream, paint, daily cream, inks, ketchup, emulsion,...	●	●	●	●	●	●	●	●	
Medium viscosity (solid particles > 10µm) ex : Cosmetic cream, road paint, emulsion, grease...	●	●	●		●	●	●	●	
High viscosity ex : Polymer, gum, cheese, gel, asphalt...					●	●	●		
Fragile Products ex : cheese, yogurt, gel...				●	●	●	●		
Solid product ex : Polymer, ...					●				
Heterogeneous products ex : Sauce, soup, cement, mortar...		●				●	●		
Application	One viscosity value (Norm ASTM2555)	One viscosity value, flow curve, rheology study as yield stress, temperature behaviour or thixotropy (norm DIN53019 or ISO 3219)				Measurement on heterogeneous product with/without particles.		Ideal for portable viscometer	Measurement according norm ASTM D562
PAGES	79	76	83	84	85	78	81	80	81

MS-DIN

These measuring systems are compatible with all instruments in the LAMY RHEOLOGY range except CP-1000/CP-2000 device, GT-300 PLUS and GT-300 PRODIG models.

These measuring systems are compatible with our temperature controls EVA DIN, EVA 100 and RT1 and water jacket CT-DIN and CT-LC.

Name	Reference	
MK - DIN 1	112820	
MK - DIN 2	112821	
MK - DIN 3	112822	
MK - DIN 9	111875i	
MB-DIN 1 Tube	112932	
MB-DIN 2 Tube	112937	
MB-DIN 3 Tube	112938	
CAP-DIN 1	112872	
CAP-DIN 2	112877	
CAP-DIN 3	112878	
CAP-DIN 1 Mooney	112874	
ST-R centring tool	114436	
MB-DIN 1 S Tube	112933	
MB-DIN 2 S Tube	112948	
MB-DIN 3 S Tube	112944	

MS-DIN

DIN 11 measuring system Ref. 112801

DIN 22 measuring system Ref. 112804

DIN 33 measuring system Ref. 112805

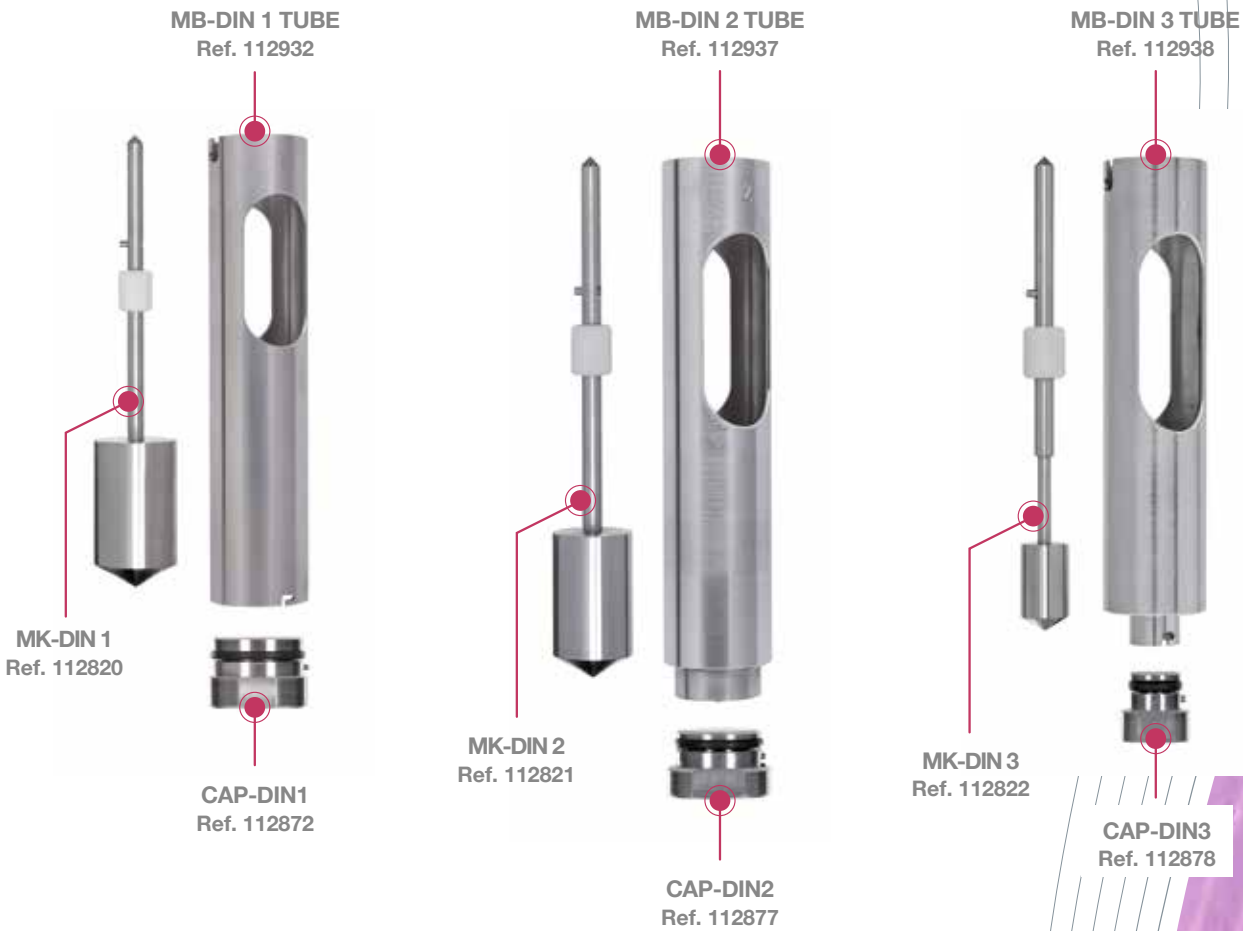

MEASURING SYSTEMS WITH BAYONET COUPLING

Measuring system *		Spindle	Cup	Cap	Volume (ml)	Shear rate (s ⁻¹)**	Viscosity range in mPa.s		
Designation	Reference	Designation	Designation	Designation			Instrument LR**	B-ONE and FIRST**	RM 100/200 and DSR 500**
MS DIN 11	112801	MK-DIN1	MB-DIN1	CAP-DIN1	27	1,29N	2,5 to 27K	25 to 0.44M	3 to 1M
MS DIN 11S***	112809	MK-DIN1	MB-DIN1S	CAP-DIN1	27	1,29N	2,5 to 27K	25 to 0.44M	3 to 1M
MS DIN 12	112802	MK-DIN2	MB-DIN1	CAP-DIN1	46	0,35N	11 to 145K	110 to 2.3M	18 to 5.5M
MS DIN 13	112803	MK-DIN3	MB-DIN1	CAP-DIN1	61	0,15N	92 to 510K	920 to 8.3M	146 to 19M
MS DIN 13S***	112808	MK-DIN3	MB-DIN1S	CAP-DIN1	22	0,15N	93 to 510K	920 to 8.3M	146 to 19M
MS DIN 19	112806i	MK-DIN9	MB-DIN1	CAP-DIN1	25	3,22N	0,8 to 10K	8 to 0.17M	1 to 0.39M
MS DIN 22	112804	MK-DIN2	MB-DIN2	CAP-DIN2	22	1,29N	4 to 53K	40 to 0.86M	7 to 2M
MS DIN 22S***	112815	MK-DIN2	MB-DIN2S	CAP-DIN2	22	1,29N	5 to 53K	40 to 0.86M	7 to 2M
MS DIN 33	112805	MK-DIN3	MB-DIN3	CAP-DIN3	14	1,29N	20 to 265K	200 to 4.3M	34 to 10M
MS DIN 33S***	112814	MK-DIN3	MB-DIN3S	CAP-DIN3	14	1,29N	20 to 265K	200 to 4.3M	34 to 10M
MS DIN 11M	112812	MK-DIN1	MB-DIN1	CAP-MOONEY	23	1,29N	2,5 to 27K	21 to 0.44M	3 to 1M
MS DIN 19M	112811i	MK-DIN9	MB-DIN1	CAP-MOONEY	18,5	3,22N	0,8 to 10K	8 to 0.17M	1 to 0.39M
MS DIN 23	112816	MK-DIN3	MB-DIN2	CAP-DIN2	36	0,19N	81 to 1M	810 to 17M	139 to 41M

M for million, K for thousand, N for rotational speed (rpm) / * Complete measuring system with spindle, cup and cap. / ** These values are given when complete system is used. / *** Include centring tool ST-R (Ref. 114436).

MS-R

Anchor-type measuring systems (316L stainless steel). These systems are ideally suited for measuring viscosity (value or curve) in the control or development of heterogeneous products, or having the appearance of soft solid at rest, present in cosmetics, paint, food or mineral chemistry industries. Used with their respective buckets, they allow to apply a shear rate.

These systems are compatible with RM 100 PLUS, RM 200 PLUS and DSR 500. These systems are compatible with our EVA DIN-MS-R PLUS and EVA MS-R PLUS temperature controls.

MS-R1 measuring system Ref. 114500

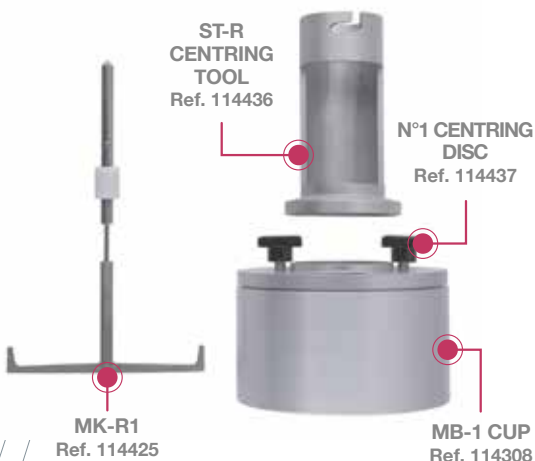

MS-R2 measuring system Ref. 114501



MS-R3 measuring system Ref. 114502

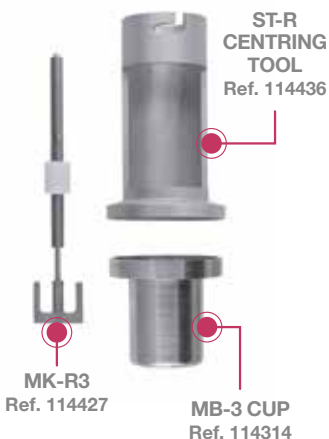

MS-R4 measuring system Ref. 114503

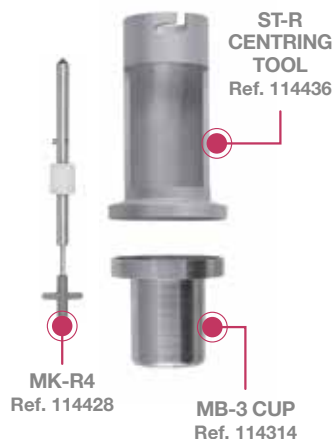

MEASURING SYSTEMS WITH BAYONETTE COUPLING

System Designation	System Reference	Complete set**** Reference	Diameter (mm)		Product Volume (ml)	Shear rate range for RM 100/200 - DSR 500 (s-1)	Viscosity range for RM 100/200 - DSR 500 (mPa.s)
			inner	outer			
MS-R1***	114500*	111949 111950	93	98	300	200 rpm	1 to 40 UD
MS-R2	114501*		46	54	70	0.105 to 525	12 to 3.6M
MS-R3	114502*		23	36	25	0.09 to 450	72 to 21.6M
MS-R4	114503*		20	36	25	0.075 to 375	400 to 120M
MK-R5	114429**		5			0.03 to 150	1.5K to 475M

M for millions, K for thousand. / * Complete system (bob+cup+centring tool). / ** Only spindle. Can be use with cup MB2 (Ref. 114311) and MB3 (Ref. 114314). / *** Can be used only at 200 rpm and UD result. / **** Complete set in case with cup and centring tool. / All data given in this table are given for information and can be changed according container used for measurement.

MS-RV/LV

Measuring spindles according to ASTM / ISO 2555 (316L stainless steel). These systems are ideally suited for simple viscosity measurement at controlled rotational speed in all areas of activity. The standard recommends use of 600ml beaker for measurement.

Name	Reference	Dimensions (mm)	
LV-1 spindle	111010	Ø 18,80 - L 65,1	
LV-2 spindle	111011	Ø 18,72 - L 6,86	
LV-3 spindle	111012	Ø 12,60 - L 1,78	
LV-4 spindle	111013	Ø 3,20 - L 31	
Axis R 1-6 without disc	111000	Threaded axis	
RV-1 Disc	111001	Ø 56,26	     
RV-2 Disc	111002	Ø 46,93	
RV-3 Disc	111003	Ø 34,69	
RV-4 Disc	111004	Ø 27,30	
RV-5 Disc	111005	Ø 21,14	
RV-6 Disc	111006	Ø 14,62	
RV-7 Spindle	111007	Ø 3,20	
Axis L-R	111008	Adaptation axis	Adaptor for Brookfield spindles 

SPINDLES WITH BAYONETTE COUPLING









Spindle Designation	Spindle Reference	Complete set** Reference	Instrument LR	Viscosity range in mPa.s	
				FIRST/B-ONE	RM 100/200 and DSR 500
RV1	111001*	111947 / 111948	Not Usable	100 to 0.6M	50 to 1.4M
RV2	111002*		200 to 0.14M	200 to 2.4M	100 to 5.5M
RV3	111003*		300 to 0.37M	300 to 6M	150 to 14M
RV4	111004*		400 to 0.74M	600 to 12M	200 to 28M
RV5	111005*		500 to 1.4M	1.2K to 24M	300 to 55M
RV6	111006*		1200 to 3.7M	2.8K to 60M	500 to 130M
RV7	111007		4500 to 15M	12K to 240M	2K to 550M
LV1	111010	111014	15 to 0.25M	200 to 4.3M	35 to 10M
LV2	111011		50 to 1.3M	1K to 20M	170 to 50M
LV3	111012		200 to 5M	4k to 82M	650 to 190M
LV4	111013		1000 to 22M	17K to 370M	3K to 860M

M for millions, K for thousand / * Need additional axis (Ref. 111000). / ** Complete set (delivered with axis Ref. 111000 only for RV spindles).

MS-BV

Measuring spindle for 150ml beaker (316L stainless steel). These spindles are ideally suited for simple viscosity measurement at a rotating speed in control in all areas of activity. They are appreciated for their ease of use and the low volume of product needed compared to the MS RV/LV spindle.

*These measuring spindles are compatible with instruments in LR version.
Compatible with EVA BV temperature control (price and item on demand).*

	Name	Reference	Dimension (mm)
	BV 1-100 Axis	117102	-
	BV centring device	117202	-
	BV Disc n°1	117001	Ø 45
	BV Disc n°10	117010	Ø 40
	BV Disc n°100	117100	Ø 20
	BV 1000 Axis	117101	Ø 4
	150-ml glass beaker	117150	Ø 50-52
	MS TI Tube	118001	Ø 50

MEASURING SPINDLES WITH BAYONET COUPLING

Designation	Reference**	Complete Set*** reference	Viscosity range FIRST/B-ONE (mPa.s)	Viscosity range RM 100/200- DSR 500 (mPa.s)
BV1	117001*	117000	15 to 0.25M	2 to 0.6M
BV10	117010*		100 to 2M	17 to 5.1M
BV100	117100*		1K to 22M	170 to 51M
BV1000	117101		10K to 220M	1.7K to 510M

*M for million, K for thousand / Use with glass beaker (Ref. 117150 for 10pcs) or plastic beaker (Ref. 117155 for 10 pcs). / * Require additional axis (Ref. 117102). / ** Require centring tool (Ref. 117202). / *** Complet Set in case with additional axis (Ref. 117102) and centring tool (Ref. 117202).*

MS-VANES

These systems are ideal for viscosity measurement (value or curve) in control or development of all types of products even very high viscosity with or without particles (size <5mm). They can be used for direct measurement in user's containers or in tubes of MS-DIN systems.



4 blades VANE



6 blades VANE



MEASURING SYSTEMS WITH BAYONET COUPLING

Designation	Reference	Diameter (mm)	Lenght (mm)	Viscosity range in mPa.s		
				LR Device	B-ONE/FIRST	RM 100/200 DSR 500
MK-V71	111114	34,39	68,78	1,4 to 18K	14 to 300K	2,4 to 700K
MK-V72**	120017	21,67	43,38	5,6 to 74K	56 to 1,2M	9,4 to 2,8M
MK-V73**	111108	12,67	25,35	28 to 370K	280 to 6M	46 to 13M
MK-V74**	111115	5,89	11,76	280 to 3,7M	2,8K to 60M	463 to 139M
MK-V75**	111111	8,026	16,05	111 to 1,4M	1,1K to 24M	185 to 55M
MK-V72/2**	111112	21,67	20	54 to 720K	540 to 11M	90 to 27M
MK-V72/4**	111113	21,67	10	80 to 1M	800 to 17M	133 to 40M
MK-V72-6P*	111121	21,67	43	30 to 400K	300 to 6,5M	50 to 15M
MK-VT105**	440105	5	10	430 to 5,8M	4,4K to 94M	726 to 218M
MK-VT2010**	442010	10	20	82 to 1M	820 to 17M	137 to 41M
MK-VT2020**	442020	20	20	12 to 150K	118 to 2,5M	20 to 5,9M
MK-VT3015**	443015	15	30	16 to 210K	160 to 3,4M	27 to 8M
MK-VT4020**	444020	20	40	7 to 90K	68 to 1,4M	11 to 3,4M
MK-VT4040	444040	40	40	1,5 to 19K	15 to 320K	2,5 to 740K
MK-VT5025**	445025	25	50	4 to 45K	34 to 730K	6 to 1,7M
MK-VT6015	446015	15	60	9 to 114K	86 to 1,8M	15 to 4,3M
MK-VT6030	446030	30	60	2 to 26K	20 to 433K	3,5 to 1M
MK-VT608	446008	8	60	30 to 400K	300 to 6,5M	50 to 15M
MK-VT8040	448040	40	80	1 to 11K	9 to 182K	2 to 420K
MK-VT8070	448070	70	80	0,5 to 3,2K	3 to 52K	1 to 120K

M for million, K for thousand / * VANE 6 BLADES. / ** These items can be used with tube MB-DIN1 (Ref.112932).

81

MS-KREBS





Krebs type measuring spindles compatible with ASTM D562 standard (316L stainless steel). These systems are ideal for viscosity measurement in Krebs units in control of all types of products. They can be used for direct measurement in user containers or in 600 or 150ml beakers.

Name	Reference	Dimension (mm)	
MK-KU 1-10	111100	L. 54,11	
MK-75Y	111103	L. 34,58	

MS-CHOCOLAT

Coaxial cylinder measuring system compatible with OICCC standard (316L stainless steel).
These measuring spindle measure viscosity and flow limit of chocolates according to Casson regressions models as recommended in OICCC standards.







These measuring systems are compatible with our EVA DIN, EVA 100 temperature controls and our water jacket CT-DIN and CT-LC.

	Name	Reference	Dimension (mm)
	MK-C	116002	Ø 13,60
	C Tube with insert	116001	Ø 20
	DIN 1 Tube	112932	Ø 32,50
	C Insert	116004	Ø 20
	Delrin cap	116005	-

MS-ULV

Measuring system for low viscosities usable with instruments LR version (Stainless steel 316L and Aluminium).
This system, unlike the MS-RV/LV or MS-DIN systems, makes it possible to measure low viscosity products in control by applying a shear rate. Its advantage is to be compatible with LR instruments.

This measuring system can be used with our temperature controls EVA DIN and RT1 and our water jackets CT-DIN and CT-LC (according to models, see table).

Name	Reference	Dimension (mm)	
MK-C19	116015P	Ø 19	
C Tube with insert	116001	Ø 20	
Delrin cap	116005	-	
C Insert	111934	-	
ST-R centring tool	114436	-	
MB-C Alu Cup	114306	Ø 20	



MEASURING SYSTEMS WITH BAYONET COUPLING FOR LR DEVICE

Designation	Reference	Included					Volume (ml)	Shear rate range (s-1)	Viscosity range (mPa.s)
		Spindle	Cup	Holder	Cap	Tool			
MS-ULV*	116030	116015P	116001		116005		21	1 to 510	1 to 26K
MS-ULV/D**	116031	116015P	114306	111394		114436	21		

*K for thousand / * Not compatible with oven RT-1. Can be used without temperature unit. / ** Include 100 disposable cup (Ref. 114306). Must be used with temperature unit or water jacket.*

MS-SV

Measuring systems for low volumes (316L stainless steel or aluminium).

These systems make it possible to measure products in small quantities by applying a shear rate at temperature up to +300°C (according to items, see table).

With RT-1 and THERMOCELL package, these systems are compatible with ASTM D3236.

These measuring systems are compatibles with small volume package SVP65/180, water jacket CT-DIN/CT-LC, THERMOCELL package and our temperature controls EVA DIN and RT-1.



Measuring cylinder
MK-SV



Measuring chamber
MB-SV13RC (Ref. 116214)



Disposable cup
MB-SV13RD (Ref. 116413)



Holder H-SV13RD
for disposable cup
MB-SV13RD
(Ref. 116313)



Measuring chamber
MB-SV13R
(Ref. 116213)



Centring tool ST-R
(Ref. 114436)



Delrin cap, temperature
maximum 80°C
(Ref. 116215)

83



MEASURING SYSTEMS WITH BAYONET COUPLING

Measuring Cylinder		Compatible chamber****		Volume (ml)	Shear rate (s ⁻¹)	Viscosity range in mPa.s		
Designation	Reference	Designation	Reference			LR device	B-ONE/ FIRST	RM 100/ RM 200/ DSR 500
MK-SV414*	116114	MB-SV6R*	116206	3	0,4N	44 to 5,8M	440 to 95M	73 to 219M
MK-SV415*	116115	MB-SV7R*	116207	4,4	0,48N	15 to 2M	155 to 33M	26 to 77M
MK-SV416*	116116	MB-SV8R*	116208	4,6	0,29N	39 to 5,2M	394 to 85M	66 to 197M
MK-SV418	116118	MB-SV13R MB-SV13RC** MB-SVD***	116213 116214 116513	7,5	1,32N	1 to 120K	9 to 1,9M	2 to 4,5M
MK-SV421	116121			8	0,93N	1 to 188K	14 to 3M	2 to 7M
MK-SV425	116125			10	0,22N	174 to 23M	1,7K to 377M	291 to 870M
MK-SV427	116127			12	0,34N	7 to 0,99M	75 to 16M	12 to 37M
MK-SV428	116128			13	0,28N	15 to 1,9M	147 to 31M	24 to 73M
MK-SV429	116129			13	0,25N	29 to 3,9M	294 to 63M	49 to 146M
MK-SV431	116131			11	0,34N	10 to 1,3M	100 to 21M	16 to 49M
MK-SV434	116134			11	0,28N	19 to 2,5M	194 to 41M	32 to 96M
MK-SVC	116002			13	0,43N	3 to 420K	32 to 6,8M	5 to 15M

M for million, K for thousand, N for rotational speed (rpm). / * Not compatible with RT-1PLUS and THERMOCELL PACKAGE. / ** This cup can be used without centring tool ST-R. Need CAP (Ref. 116215). Temperature max 80°C. / *** This item include 100 disposable cup MB-SV13RD (Ref. 116413) and holder H-SVRD (Ref. 116313). / **** These items need centring tool ST-R (Ref. 114436 include with THERMOCELL and SVP65/180).

MS-CP

Measuring systems compatible with DIN 53019 / ISO 3219 / ASTM D4278-D7395 (316L Stainless Steel).

These systems make it possible to set the shear rate in order to carry out viscosity measurements or to obtain curves to study flow behaviour, yield stress or thixotropy.

They are particularly suitable for measurements on very small quantities for control or development of homogeneous products with or without particles (size <100µm), guaranteeing easy cleaning.

AC 265 coupling guarantees rapid set-up of the measuring system, better maintenance and increased repeatability.

These measuring systems are compatible with FIRST PRODIG CP-1000, RM100 CP-1000 and RM100 CP-2000.



MK-CP 40 mm AC 265

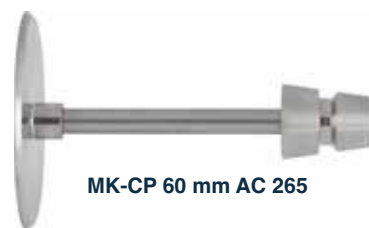

MK-CP 60 mm AC 265



MEASURING SYSTEMS FOR CP-1000 AND CP-2000 INSTRUMENTS

Designation	Reference	Diameter (mm)	Angle (°)	Volume (ml)	Shear rate (s ⁻¹)	Viscosity range in mPa.s	
						FIRST PRODIG CP1000	RM100 CP1000 / CP2000
MK-CP1005	265115	10	0,5	0,002	12N	640 to 13M	106 to 31,8M
MK-CP1020	265120	10	2	0,01	3N	2,5K to 55M	424 to 127M
MK-CP1030	265130	10	3	0,01	2N	3,8K to 80M	637 to 191M
MK-CP06	2651418	14,04	1,8	0,02	3,3N	840 to 18M	139 to 41,8M
MK-CP03	2651945	19,06	0,45	0,015	13,3N	85 to 1,8M	14 to 4,1M
MK-CP05	2651918	19,06	1,8	0,05	3,3N	335 to 7,2M	56 to 16,7M
MK-CP09	2651930	19,06	3	0,1	2N	550 to 11,9M	92 to 27,3M
MK-CP2005	265205	20	0,5	0,018	12N	80 to 1,7M	13 to 3,9M
MK-CP2015	265215	20	1,59	0,058	3,8N	250 to 5,4M	42 to 12,5M
MK-CP2020	265202	20	2	0,073	3N	320 to 6,8M	53 to 15,9M
MK-CP02	2652445	24	0,45	0,03	13,3N	42 to 0,9M	7 to 2M
MK-CP2405	265245	24	0,5	0,031	12N	46 to 1M	8 to 2,3M
MK-CP51Z	2652415	24	1,5	0,1	4N	140 to 2,9M	23 to 6,9M
MK-CP04	2652418	24	1,8	0,12	3,3N	170 to 3,6M	28 to 8,3M
MK-CP2420	265242	24	2	0,126	3N	190 to 3,9M	31 to 9,2M
MK-CP52Z	265243	24	3	0,2	2N	280 to 5,9M	46 to 13,8M
MK-CP01	265345	30,2	0,45	0,06	13,3N	20 to 0,4M	3 to 1M
MK-CP10	2653012	30,2	1,2	0,15	5N	60 to 1,2M	9 to 2,7M
MK-CP08	2653030	30,2	3	0,38	2N	140 to 3M	23 to 6,9M
MK-CP4005	265405	40	0,5	0,146	12N	10 to 0,2M	2 to 0,5M
MK-CP4010	265401	40	1	0,29	6N	20 to 0,4M	3 to 1M
MK-CP4015	265515	40	1,59	0,465	3,8N	32 to 0,7M	5 to 1,5M
MK-CP4020	265402	40	2	0,585	3N	40 to 0,8M	7 to 2M
MK-CP4040	265404	40	4	1,17	1,5N	80 to 1,7M	13 to 4M
MK-CP07	2654830	48	3	1,5	2N	35 to 0,7M	6 to 1,7M
MK-CP40Z	265488	48	0,8	0,4	7,5N	9 to 0,2M	2 to 0,4M
MK-CP42Z	2654815	48	1,5	0,76	4N	18 to 0,3M	3 to 0,8M
MK-CP41Z	265483	48	3	1,5	2N	35 to 0,7M	6 to 1,7M
MK-CP5005	265505	50	0,5	0,285	12N	5 to 0,1M	1 to 0,2M
MK-CP5020	265502	50	2	1,142	3N	21 to 0,4M	3 to 1M
MK-CP6005	265622	60	0,5	0,5	12N	3 to 60K	1 to 0,1M
MK-CP6010	265610	60	1	1	6N	6 to 0,1M	1 to 0,3M
MK-CP6020	265602	60	2	2	3N	12 to 0,25M	2 to 0,6M
MK-CP6030	265603	60	3	3	2N	18 to 0,3M	3 to 0,9M

M for million, K for thousand, N for rotational speed (rpm)

MS-CP

Measuring systems compatible with DIN 53019 / ISO 3219 / ASTM D4278-D7395 (316L Stainless Steel). All cones-plate presented on this page present a truncation (50µm) compatible with our instruments with automatic lift.

They are particularly suitable for measurements on very small quantities for control or development of homogeneous products with or without particles (size <5µm for cone-plate), guaranteeing easy cleaning. AC 265 coupling guarantees rapid set-up of the measuring system, better maintenance and increased repeatability.

These measuring systems are compatible with RM 200 CP-4000 and DSR 500 CP-4000.



MK-CP 20 mm AC 265



MK-CP 50 mm AC 265



MEASURING SYSTEMS FOR RM200/DSR500 CP4000 PLUS

Designation	Reference	Diameter (mm)	Angle (°)	Volume (ml)	Shear rate (s-1)	Viscosity range (mPa.s)
MK-CP1010	365101	10	1	0,005	6N	212 to 63,6M
MK-CP2005	365205	20	0,5	0,018	12N	13 to 3,9M
MK-CP2010	365210	20	1	0,04	6N	26 to 7,9M
MK-CP2020	365202	20	2	0,073	3N	53 to 15,9M
MK-CP2404	365244	24	0,45	0,03	13,3N	7 to 2M
MK-CP2405	365245	24	0,5	0,031	12N	8 to 2,3M
MK-CP3510	365351	35	1	0,2	6N	5 to 1,4M
MK-CP4005	365405	40	0,5	0,146	12N	2 to 0,5M
MK-CP4010	365401	40	1	0,29	6N	3 to 1M
MK-CP4020	365402	40	2	0,585	3N	7 to 2M
MK-CP4040	365404	40	4	1,17	1,5N	13 to 4M
MK-CP5005	365505	50	0,5	0,285	12N	1 to 0,24M
MK-CP5020	365502	50	2	1,142	3N	3 to 1M
MK-CP6010	365601	60	1	1	6N	1 to 0,3M
MK-CP6020	365602	60	2	2	3N	2 to 0,6M
MK-CP6005	365605	60	0,5	1	12N	1 to 0,1M

M for million, K for thousand, N for rotational speed (rpm).

85

MS-PP

Designation	Reference	Diameter (mm)	Volume* (ml)	Shear rate* (s-1)	Viscosity range* (mPa.s)
MK-PP20	265020	20	0,314	1N	200 to 61,1M
MK-PP25	265025	25	0,491	1,3N	83 to 24,8M
MK-PP28	265028	28	0,616	1,5N	52 to 15,7M
MK-PP35	265035	35	0,962	1,8N	22 to 6,5M
MK-PP40	265040	40	0,63	4,2N	6 to 1,9M
MK-PP50	265005	50	1	5,2N	3 to 0,78M

M for million, K for thousand, N for rotational speed (rpm) / * Given values for gap 1mm



**SERVICES &
SUPPORT**

SERVICES & SUPPORT

- 88 APPLICATIONS
- 89 TRAINING
- 90 CHECKING, CALIBRATION AND SERVICE
- 91 DISTRIBUTORS

APPLICATIONS

FIND ALL OUR APPLICATIONS

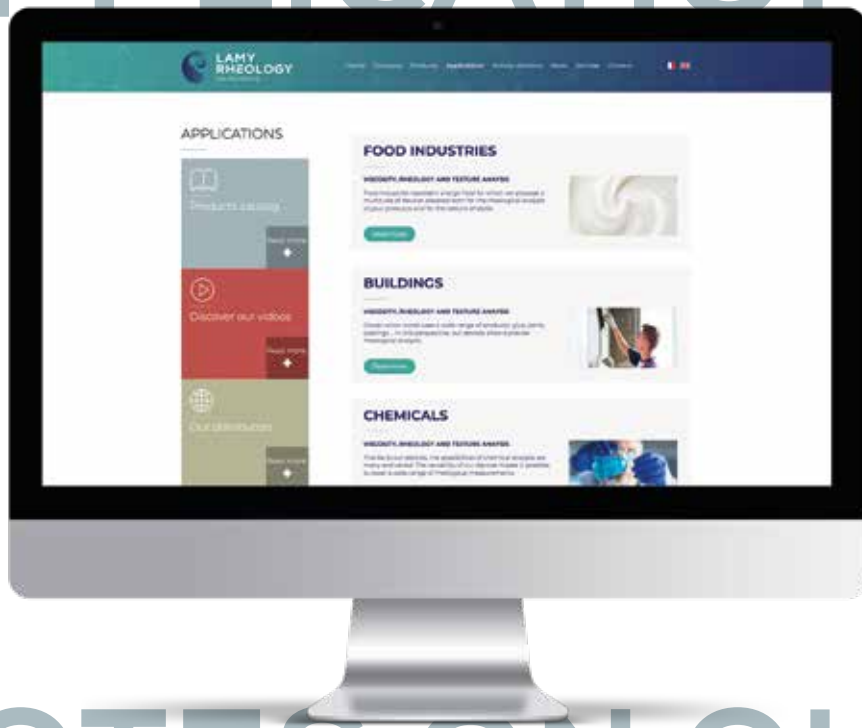

NOTES ON OUR WEB SITE

TRAINING

Four values to meet your training needs

1 - AVAILABILITY

Our partners will propose regular visits so you can optimise your products and they will help you set the perfect measurement conditions.

2 - PERFORMANCE

Our instruments are demonstrated using your samples to help you choose the right equipment for your needs.

3 - COMPLIANCE

IQ procedures: a technician will take charge of documenting the installation so that you can start using your equipment immediately.

OQ/PQ Procedures: verification that results are obtained from the first measurement by ensuring that the equipment meets specifications in the given environment.

4 - EXPERTISE

Rheology training sessions applied in the business: understand and explain physical phenomenon revealed by the rheological behavior and texture analyses of your formulations.

“ **Because understanding each and every one of our customers means we can meet everyone's expectations!** ”

CHECKING, CALIBRATION AND SERVICE

Guaranteed smooth running of your instruments.

Planned calibration and preventive maintenance, carried out by our trained and certified technicians, are essential to guarantee your instruments run smoothly so that productivity is increased and reliable, accurate measurements are obtained.

So you can benefit from our technicians' experience, we offer:

- Calibration with validation certificates (assessment of your device and free quote).
- Provision of verification oils.
- Tests according to your conditions of use.

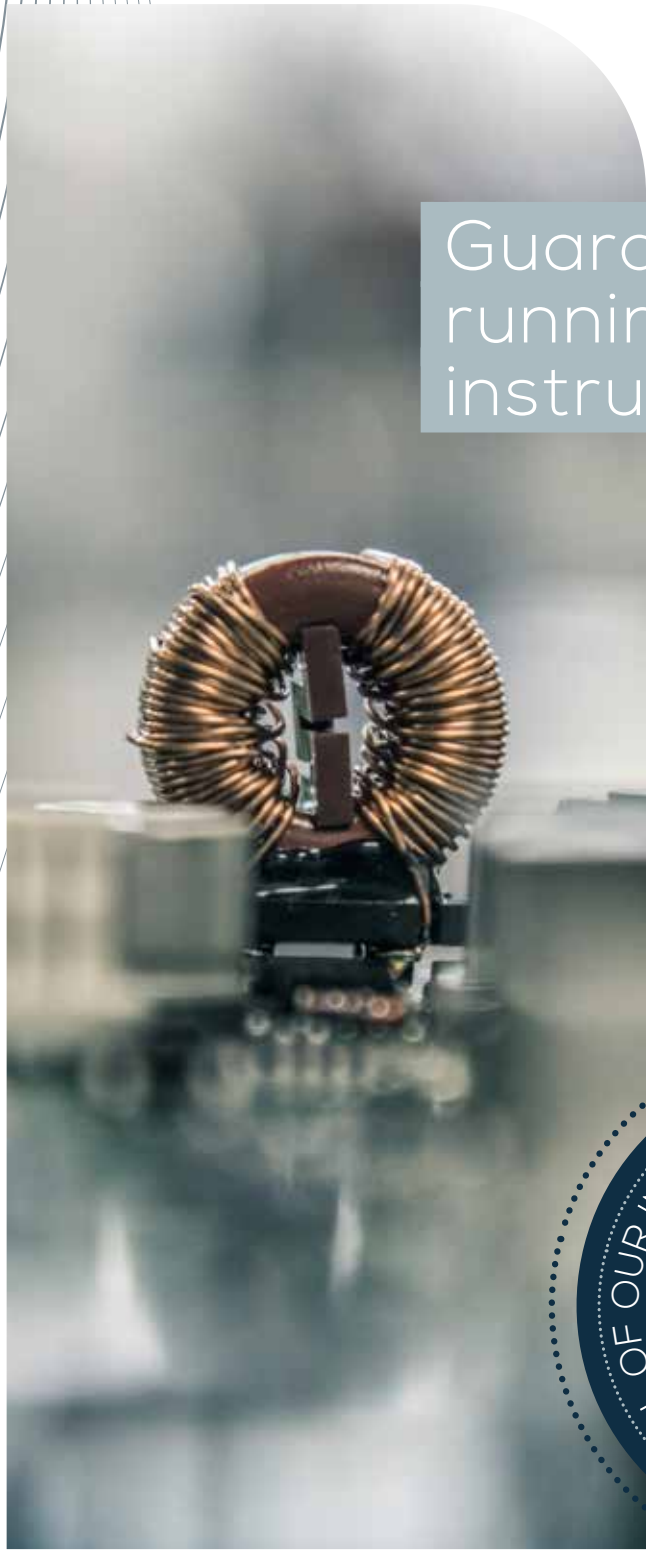

DISTRIBUTORS

Go to
www.lamyrrheology.com
 to see a list
 of our distributors



AMERICA

Brazil
 Canada
 Colombia
 Guatemala
 Honduras
 Mexico
 Salvador
 United States

EUROPE

Austria
 Belgium
 Bosnia
 Bulgaria
 Croatia
 France
 Germany
 Greece
 Hungary
 Ireland
 Italy
 Netherlands
 Poland
 Portugal
 Romania
 Serbia
 Spain
 Ukraine
 United Kingdom

AFRICA

Benin
 Egypt
 Morocco
 Nigeria
 Tunisia

ASIA

Bangladesh
 China
 India
 Indonesia
 Iran
 Israel
 Japan
 Jordan
 Lebanon
 Malaysia
 Pakistan
 Philippines
 Qatar
 Russia
 Singapore
 South Korea
 Taiwan
 Turkey
 United Arab Emirates
 Vietnam

OCEANIA

Australia
 New Zealand



Tel : +33 (0)4 78 08 54 06
Fax : +33 (0)4 78 08 69 44
contact@lamyrheology.com

www.lamyrheology.com

11 A, rue des Aulnes
69410 Champagne au Mont d'Or
France